



WINNEBAGO TOWABLES
OWNER'S MANUAL

MODEL YEAR 2023

Table of Contents

Thank you!	4
Go Where You Feel	5
Introduction	
About This Manual	6
Initial Dealer Responsibility	7
Pre-Delivery Inspection	8
Owner's Responsibility	9
Obtaining Service	10
Customer Service Department	11
Winnebago VIN Explained	12
Red Thread Items	13
Safety	
Safety Symbols	14
Formaldehyde Information	15
Chemicals & Offgassing	16
United States Safety Reporting	17
Canadian Safety Reporting	18
Pre-Travel	
Pre-Travel Information	19
Tire Safety	23
How To Read A Tire Sidewall	24
Axles & Suspension	31
Towing & Leveling	
Towing & Leveling	33
Hitching Up	36
7-Way Connector Plug	37
Brake System Components	38
Parking & Leveling	41
Appliances	
Appliances Information	42

Carbon Monoxide	47
Heating & Cooling	48
Propane System	49
Electrical Systems	53
Plumbing System	
Plumbing System	60
Winterization Process	64
Entertainment Systems	66
Furniture & Soft Goods	67
Slide-Out System	
Slide-Out System	69
Schwintek In-Wall Slide-Out	70
Norco NXG Slide Mechanism	73
Interior Care	76
Exterior Care	77
Maintenance & Storage	
Maintenance & Storage	80
Required Maintenance Schedule	81
General Cleaning Instruction	84
Miscellaneous Information	85
Troubleshooting	86
Supplier Contact Information	90
Index	91
Maintenance Notes	96
Warranty	101
Coach-Net	106

You don't just buy Winnebago, You join Winnebago.

If you're new here, Welcome! Thank you for choosing to purchase a Winnebago travel trailer for your next adventure! If you're already a part of the Winnebago family, Welcome back! We thank you for your continued support and trust.

We are for the boundless adventurers and travelers who have a drive for experiencing what's next with those who matter to us most. Winnebago provides a community united by pride and a sense of belonging. With our commitment to Quality, Innovation, and Consumer Trust, we take you further, for longer. So that you can always be bound by the adventure ahead.

Winnebago assembles travel trailers to standards which meet or exceed local, state, and national codes including those from the Recreational Vehicle Industry Association. Each trailer has been thoroughly inspected at our facility prior to shipment.

When a dealer partners with Winnebago, they experience support that is unmatched by any other. This allows you to receive quality support and service when you need it most.

Welcome to the Winnebago Family!

For those seeking something else, the way out is there.

Beyond the beaten path is a different kind of road. Sometimes it's dirt. Other times, stone. Maybe a river painted in roaring rapids or a clearing between two pines. Follow it. It leads to more than a destination. To places you don't just find, but somehow find you. Where salt kicked from the sea, and crumbled leaves under a canopy of trees, and a cliffside lookout across technicolor valleys are things you feel deeper than touch. And sight. And sound. Unlike conditioned air and laminate floors, they feel different. They feel real. So you can feel something real within you, too.

About This Manual

This manual has been compiled to assist campers, both novice and experienced in the set-up, use, and preventative maintenance required for continued enjoyment of your travel trailer. If after taking delivery of your new trailer it requires additional adjustment, please contact your dealership as soon as possible to schedule a service appointment.

This Owner's Manual, along with information provided in the Red Winnebago Information bag, outlines important areas of operation, and provides maintenance schedules to ensure safe, trouble-free service. Knowledge of trailer usage, components, and maintenance will help you enjoy your adventures to the fullest.

Please thoroughly read and understand the content of this Owner's Manual before your maiden voyage. Pay additional attention to the safety precautions denoted by "Danger", "Caution", "Warning", and "Information".

Our One-year Limited Base Warranty and Three-year Limited Structural Warranty are included in this Manual. Please thoroughly read and understand these as well.

NOTE: This Manual is of a general nature only. Some equipment and features described or shown in this manual may not be available in your model. Because of the Winnebago Towables continuous program of product improvement, it is possible that recent product changes and information may not be included.

This Owner's Manual will provide general information and instruction. Product information or instruction may not apply, may be excluded or may be generalized because:

- Equipment and features described or shown may be optional or unavailable on some models.
- Ongoing design changes may not be included because of continuous product development and improvement.
- The information in this manual is accurate at the time of publication but specifications are subject to change without notice.

Descriptions and photographs in this manual are representative of function and may not specifically depict actual equipment, fabrics, interior or exterior décor or design options as installed on your trailer.

THIS PRODUCT IS DESIGNED FOR RECREATIONAL USE AND SHORT-TERM OCCUPANCY ONLY.

Winnebago travel trailers are not designed or intended to be used as permanent housing. Using this product for long term or permanent occupancy may lead to premature deterioration of appliances, plumbing, interior finishes, fabrics, carpeting and drapes. Damage or deterioration due to long term occupancy is not considered normal, and constitutes misuse or abuse under the warranty terms, therefore voiding your warranty protection.

YOU ARE RESPONSIBLE FOR THE SAFE OPERATION AND USE OF YOUR TRAVEL TRAILER.

Initial Dealer Responsibility

Winnebago assembles travel trailers to standards which meet or exceed local, state, and national codes. Each trailer has been thoroughly inspected at our facility prior to shipment. Every Winnebago dealer has the responsibility to reinspect and prepare each unit after they arrive from transport. Listed below is an overview of the process your dealer should complete before you take ownership of your new RV;

- Complete a Pre-Delivery Inspection (PDI) to ensure all systems and components work properly after transport and prior to retail sales.
- Prepare travel trailer for pre-delivery phase of sale.
- Provide a basic travel trailer use and features orientation to ensure you have basic knowledge of how to properly operate.
- Complete a Retail Post-Delivery Inspection using the checklist show on the following page.
- Review all warranty information including but not limited to the Limited Base Warranty, Limited Structural Warranty, and any warranty information associated with components or appliances.
- Provide you with a complete Red Winnebago Information bag including in your unit upon delivery.
- Answer any and all questions related to service, warranty, registering your unit, etc.

RETAIL POST-DELIVERY INSPECTION REQUIREMENTS

VIN _____

Dealer Code No. _____

Model ____ Year ____ Length ____

Dealer _____

Inspected by _____

Address _____

Date Delivered _____

City _____ State _____

Owner's Name _____

Inspect the follow and correct as necessary

I. TIRES

Check and correct as necessary.

- ____ Tire pressure checked
- ____ Torque Lug Nuts

II. BRAKES

Check operation and correct as necessary.

- ____ Breakaway Switch Operation
- ____ Trailer Brake operation

III. HITCH CONNECTION

Check operation and correct necessary.

- ____ Coupler & Jack Function
- ____ Safety Chains
- ____ Hitch Cord

IV. FRESH WATER SYSTEM

Inspect operation and check for leakage – correct as necessary

- ____ 1. Water Test System
- ____ 2. Water Intake Valve
- ____ 3. Water Tank(s)
- ____ 4. Demand Pump
- ____ 5. Water Heater and Connections
- ____ 6. Water Lines – all
- ____ 7. Drain Cocks
- ____ 8. Faucets/Fixtures – all
- ____ 9. Water filter operation

V. WASTE DRAINAGE SYSTEM

Inspect and correct as necessary

- ____ 1. Holding Tank(s) and Connections
- ____ 2. Waste Drain Valve(s)
- ____ 3. Waste Drain Hose
- ____ 4. Toilet
- ____ 5. Drain Traps - all
- ____ 6. Water Heater By-pass Valve
- ____ 7. Winterize (if necessary)

VI. LP GAS SYSTEM

Inspect and correct as necessary

- ____ 1. LP system (Gas Leak test)
- ____ 2. LP Gas Bottle and Controls
- ____ 3. LP Gas Regulator
- ____ 4. Furnace – burners - controls
- ____ 5. Range – burners - controls
- ____ 6. Refrigerator – burner - controls
- ____ 7. LP Leak Detector

VII. ELECTRICAL SYSTEM

Check operation and correct as necessary

- ____ 1. 110 Volt AC System
- ____ 2. Ground Fault Circuit Interrupter (GFCI)
- ____ 3. 110 Volt Auxiliary Generator Operation

- ____ 4. 12 Volt DC System
- ____ 5. Power Converter Operation
- ____ 6. Interior Switches – all
- ____ 7. Interior and Exterior lights - all
- ____ 8. Water and Holding Tank Level Indicators
- ____ 9. Demand Water Pump Operation
- ____ 10. Interior Fans - all
- ____ 11. Furnace Thermostat
- ____ 12. Air Conditioner(s)
- ____ 13. Water Heater Operation (must be filled with water)
- ____ 14. Refrigerator Operation - Icemaker
- ____ 15. Microwave or Microwave/Convection Oven
- ____ 16. Audio/Video Equipment
- ____ 17. Slideout Rooms

VIII. EXTERIOR

Check operation and correct as necessary

- ____ 1. Doors and Locks – all
- ____ 2. Screen Door
- ____ 3. Entrance Step
- ____ 4. Windows – crank mechanisms/slides, etc.
- ____ 5. TV Antenna mechanism
- ____ 6. Vents - all
- ____ 7. Exterior Compartment Doors

IX. INTERIOR

Check operation and correct as necessary

- ____ 1. Water Demand Pump Switch
- ____ 2. TV/Cable Receptacle(s)
- ____ 3. Cabinet Door latches and hinges
- ____ 4. Drawers and Slides
- ____ 5. Curtains/Blinds
- ____ 6. Beds, Couches, Tables
- ____ 7. Fire Extinguisher (check CHARGE ONLY)
- ____ 8. CO Detector
- ____ 9. Smoke Alarm

X. GENERAL APPEARANCE

Inspect and correct as necessary

- ____ 1. Wash Vehicle
- ____ 2. Interior/Exterior Trim Moldings and Sealants
- ____ 3. Exterior Finish – spot paint, touch up & rub out if necessary
- ____ 4. Assure vehicle is in clean, presentable condition – remove all unnecessary tags, stamps, and labels.
- ____ 5. Assure owner is properly instructed in trailer loading, weight distribution and hitch and tow vehicle requirements.

DEALER SIGNATURE _____

Date _____

Owner's Responsibility

Along with the many adventures and memories of a lifetime you are sure to find in your new Winnebago, there comes many responsibilities as well. You are responsible for the regular care and maintenance of your travel trailer. This includes but is not limited to those listed in this manual as well as, those listed in the component manufacturer's manuals. When performing routine care and maintenance or repairs it is your responsibility to have these services performed at an authorized Winnebago Towables dealer. This is important for any warranty claims, as improper maintenance and neglect may result in voided warranty's.

For best care and maintenance we recommend you schedule service appointments at your dealership of purchase. This allows you to build a relationship with this dealership. They will also have first hand knowledge on the delivery and previous service performed on your specific trailer.



IMPORTANT!

Add your dealership contact information below:

Dealership: _____

Address: _____

Phone: _____



IMPORTANT!

Owner's Name: _____

Address: _____

Phone: _____

VIN: _____

Trailer Delivery Date: _____

Owner's Contact Information

In order to ensure we can contact you in the event of a recall or customer notification, we kindly ask that you notify us in writing or by email in the event the following information changes:

- Home address
- Travel trailer ownership
- Your travel trailer is stolen, totaled, or destroyed

Please notify us if you sell your Winnebago travel trailer or purchase a used Winnebago travel trailer.

To update your contact information:

Email: wtowRetailRegistrations@winnebagoind.com

Write: 201 14th St. Middlebury, Indiana 46540

Obtaining Service

Make an Appointment:

Always make an appointment in advance with the service center. Schedule as far in advance as possible, and always confirm the appointment as the date approaches.

Important Information:

Please be able to provide the following information both when making an appointment and at the time of service; Your personal contact information, Your RV's VIN, Dealer of purchase (if different), and Date of purchase.

Preparation for an Appointment:

If you have an upcoming appointment for warranty service, be sure to have the correct papers with you. Take your Warranty Registration paperwork and owner's packet with you to your appointment. Not all work to be performed may be covered by the warranty. Keep a maintenance log of your trailer's service history. This can often provide clues to the current problem.

Prepare a List:

Make a written list of your trailer's problems or the specific work you would like completed. If you've had an accident or work done that is not recorded in your maintenance log, let the service advisor know at the beginning of your appointment.

Be Reasonable with Requests:

Discuss the situation with the service advisor and list your items in order by priority. Please do not add additional maintenance requests beyond those given when the appointment was scheduled. The service center may be able to complete the additional requests, however, their schedule has been determined based on your original request.

Inspecting Repairs:

Both Winnebago and your servicing dealer want you to be satisfied with any repair. After a repair is performed, inspect the workmanship carefully. Check your service list and go over the repairs with the service center representative. Once satisfied, sign the Winnebago claim form. In the event a problem should reoccur after you have left the dealership, contact the repair center or Winnebago customer service as soon as possible in order to resolve the situation in a timely manner.

If You Need Assistance:

Winnebago and our dealers goal is to ensure you are satisfied with your purchase. We want you to be happy with our products and our services. Your selling dealer is best equipped to provide prompt resolution for any warranty issue or related matter that you may experience. Winnebago dealers have the facilities, trained technicians, special tools, and the latest information to assure your travel trailer is fixed correctly and in a timely manner. If special circumstances arise, talk to your dealer's service manager. Most matters can be resolved by following this process. If you are not satisfied after completing this process, talk to the general manager or owner of the dealership. They want to know if you need assistance, and will do their best to find a resolution. If your dealership is unable to resolve the concern, you may contact Winnebago Customer Service.

Customer Service Department

Factory: 201 14th St. Middlebury, Indiana 46540
Service Center: 5200 Hoffman St. Elkhart, Indiana 46516
Phone: (574) 825-8052
Fax: (574) 825-0818
Email: RetailWOI@Winnebagoind.com

Customer Service Communication:

When communicating with Winnebago Customer Service, please include the following information:

- Owner's Name and Address
- Owner's Phone Number
- Dealership Name and Address
- Vehicle Identification Number
- Trailer Delivery Date

Winnebago VIN Explained

VEHICLE IDENTIFICATION NUMBER:

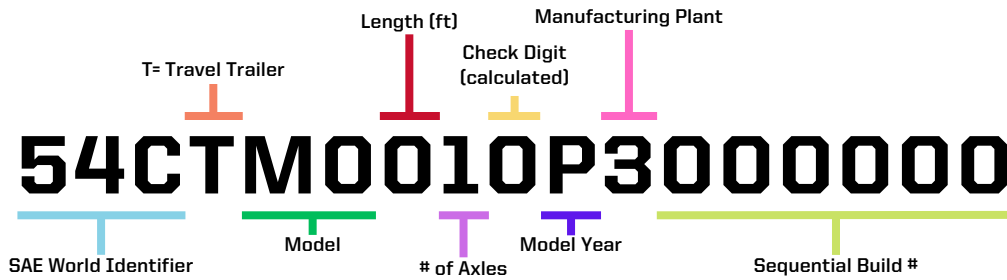

SAE World Identifier:	54C- Winnebago Towables
Trailer Type:	T- Travel Trailer
Trailer Model:	H-2- Hike 100, M1- Minnie, M2- Micro Minnie, M7- Micro Minnie FLX, V1- Voyage TT
Length:	A letter associated with the unit length
Axle Configuration:	1= Single Axle, 2= Double Axles, 3= Triple Axles
Check Digit:	Calculated to verify VIN accuracy
Model Year:	N- 2022, P- 2023
Manufacturing Plant:	3= Plant 3, 4= Plant 4, 6= Plant 6, 7= Plant 7, 8= Plant 8

Red Thread Items

We strive to set the standard for quality in our travel trailers, working every day to improve upon these levels of excellence. We are driven to do things right the first time in all we do. We apply technology and ingenuity to develop innovative and differentiated solutions, valued by our customers.

With this goal in mind, every Winnebago travel trailer is equipped with the Red Thread items listed in the packages below:



- Laminated block foam sidewalls
- Radiant technology foil wrapping
- Roof-mounted A/C systems
- Tinted windows
- Insulated heating ducts
- Heated tanks
- Enclosed underbelly



- Roof-mount solar prep
- Propane heating system
- Heavy duty axles and suspension
- Integrated Wi-Fi router installation prep
- Battery disconnect switch
- Power awning with LED lighting

Safety Symbols

We care about your safety. Like we said, you don't just buy Winnebago, you join Winnebago.

Below are the symbols you will see used throughout this Manual to depict potentially dangerous situations or the items that may cause them.



CAUTION ALERT SYMBOL

CAUTION indicates a hazardous situation which, if not avoided, could result in minor or moderate injury.



WARNING ALERT SYMBOL

WARNING indicates a hazardous situation which, if not avoided, could result in death or series injury.



DANGER ALERT SYMBOL

DANGER indicates a hazardous situation which, if not avoided, will result in death or serious injury.



INFORMATION SYMBOL

IMPORTANT indicates important information and valuable resource to remember.

Formaldehyde Information

Some of the materials used in this RV emit formaldehyde. Eye, nose, and throat irritation, headache, nausea, and a variety of asthma-like symptoms, including shortness of breath have been reported because of formaldehyde exposure. Reactions to exposure may vary among individuals. Elderly individuals, young children, and anyone with a history of asthma, allergies, or lung problems may be at a greater risk.

Research is continuing the possible long-term effects of exposure. Inadequate ventilation may allow formaldehyde and other contaminants to accumulate in indoor air. Ventilation to dilute the indoor air may be obtained from a passive or mechanical ventilation system. Always be sure to thoroughly ventilate your RV before and during each use.

High indoor temperatures and humidity may raise formaldehyde levels. When a recreational vehicle is in areas subject to high temperatures, an air conditioning system can be used to control indoor temperature levels.

If you have any questions regarding the health effects of formaldehyde, consult your doctor or local health department



WARNING!

This vehicle contains composite wood products that comply with the applicable California Code of regulations Section 93120.2(a) Phase 2 (P2) formaldehyde emission standards specified on the above date of manufacture.



WARNING!

Formaldehyde levels in the indoor air can cause temporary eye and respiratory irritation and may aggravate respiratory conditions.

Chemicals & Offgassing

After purchasing your new Winnebago travel trailer, or after taking it out of storage, you may notice a chemical odor. This is normal and can be attributed to Offgassing, the release of a chemical gas that was dissolved, trapped, frozen or absorbed in a material. The amounts present will decrease over time.

Offgassing can occur in your home as well. The materials used in home and RV construction including carpet, linoleum, plywood, insulation, etc. may outgas different chemicals. Formaldehyde, as discussed on the previous page, is one of the main chemicals. Due to the size of RV's, the air flow is much less than in a home. This allows the offgassing of chemicals to be more noticeable.

Some individuals may experience chemical sensitivity. This can cause irritation of the eyes, nose, and throat and/or nausea, headaches, or asthma-like symptoms. As mentioned on the previous page, elderly individuals, young children, and anyone with a history of asthma, allergies, or lung problems may be at a greater risk.

To reduce the chemical odor:

- Empty your RV completely.
- Set furniture pillows up on their sides.
- Open all drawers and doors.
- Close all windows and entry doors.
- Close and cover all vents,
- Turn the heat on high, and leave it running at that level for a day.
- Open everything up...doors, windows, vents, etc.
- Turn on the fans, and let the coach air out for several hours.



INFORMATION!

If you have any questions regarding the health effect of offgassing chemicals including formaldehyde, consult your doctor or local health department.

United States Safety Reporting

If you believe that your Winnebago Travel Trailer has a defect, which could cause a crash, injury, or death, immediately inform the National Highway Traffic Safety Administration (NHTSA) in addition to notifying Winnebago Towables.

If the NHTSA receives similar complaints, they may open an investigation. If they find that a safety defect exists in other vehicles, they may order a recall and remedy campaign.

However, the NHTSA cannot become involved in individual problems between you, your dealer, or Winnebago.

NHTSA Contact Information:

Vehicle Safety Hotline:	Toll-free: 1-888-327-4236 TTY: 1-800-424-9153
Website:	www.safercar.gov
Report:	www.nhtsa.gov/report-a-safety-problem#vehicle
Address:	NHTSA Headquarters Attn: Administrator 1200 New Jersey Avenue SE, West Building Washington, DC 20590

Information may be obtained about vehicle safety from the hotline or online at their website listed above.

Canadian Safety Reporting

If you believe that your Winnebago Travel Trailer has a defect, which could cause a crash, injury, or death, immediately inform Transport Canada's Defect Investigations & Recalls Division in addition to notifying Winnebago Towables.

If Transport Canada receives similar complaints, they may open an investigation. If they find that a safety defect exists in other vehicles, they may order a recall and remedy campaign.

However, they cannot become involved in individual problems between you, your dealer, or Winnebago.

Transport Canada Contact Information:

Vehicle Safety Hotline: Toll-free in Canada: 1-800-333-0510 International: 1-819-994-3328
Website: www.tc.gc.ca
Address: Transport Canada
Attn: Defect Investigations & Recall Division
330 Sparks Street, Ottawa, ON
ON K1A 0N5, Canada

Information may be obtained about vehicle safety from the website listed above.

Pre-Travel Information

Weight Ratings

The Trailer Weight Information label (located inside the lower bar on the screen door on most trailers) provides weight data critical to understanding the maximum load of your travel trailer.

GVWR

Gross Vehicle Weight Rating

This is the maximum permissible weight of the trailer. The weight of the empty trailer, plus weight added in the form of water, food, clothing, and any other additional cargo must not exceed the GVWR. GVWR is greater than or equal to the Unloaded Vehicle Weight + the Cargo Carrying Capacity.

UVW

Unloaded Vehicle Weight

This is the weight of the travel trailer as manufactured. This is the weight on the trailer axles and tongue or pin.

CCC

Cargo Carrying Capacity

This is the maximum weight of personal belongings, food, fresh water, propane gas, tools, accessories, etc., that can be loaded.

GAWR

Gross Axle Weight Rating

This represents the allowable empty vehicle's axle weight + Cargo Carrying Capacity excluding the hitch weight. The weight is divided between each axle to show each axle's own GAWR. The total from axle load + tongue weight must not be greater than the trailer's GVWR. The GAWR is located on the manufacturer's Federal ID label on the camp side front corner of the trailer.

To Determine Trailer Weight

To determine the weight of a loaded trailer:

- Locate a public weight scale.
- Park your trailer and disconnect it with all wheels and jacks on the scale.
- The reading will be the Gross Vehicle Weight of the trailer and should not exceed the GVWR as indicated on the manufacturer Federal ID tag.

To Determine Gross Axle Weight- Both Axles:

- Leave trailer connected to the tow vehicle.
- Be certain the trailer is level.
- Leave the tow vehicle off the scale.
- Drive forward until both axles are on the scale.
- The reading will be the Gross Axle Weight for both axles.

To Determine Gross Axle Weight- Each Axle:

- Leave trailer connected to the tow vehicle.
- Be certain the trailer is level.
- Leave the tow vehicle off the scale.
- Drive forward so only the rear trailer axle and tires are on the scale.
- The reading will be the Gross Axle Weight for the rear axle.
- Subtract the rear axle weight from the total Gross Axle Weight to calculate the front axle weight.

To Determine Hitch Weight:

- $\text{Gross Axle Weight} - \text{Gross Vehicle Weight} = \text{Loaded Hitch Weight}$
 - If equalizer equipment is installed, this will affect both hitch and axle weight.
-

Important

- Determine hitch and axle weights with both vehicles level.
- Tilting the trailer forward will add front axle weight.
- Hitch weight and tension of the equalizer bars will be affected by leveling the trailer and tow vehicle.
- If equalizer bars are being used, level the tow vehicle.
- Ensure all tire pressures are the same as the specifications indicated on the tire sidewalls.

CONSIDER LOAD WEIGHTS WHEN DETERMINING WEIGHT DISTRIBUTION. PROPER TRAILER POSITIONING AND LOADING ARE IMPORTANT NOT ONLY FOR EASE OF HAULING, BUT FOR SAFETY. REMEMBER: 10-15% OF A TRAVEL TRAILER'S WEIGHT SHOULD BE ON THE HITCH.

Heavier items should be placed over the axles. Avoid placing excessive weight at the front of the rear of the trailer.

Excess weight in or on the rear of the trailer can have a negative effect on the stability of both vehicles.

Stability and weight can be affected if waste is in the holding tanks or water is in the freshwater holding tank.



CAUTION!

DO NOT attach such items as motorcycles, fuel, or water containers, etc., on the rear of your trailer.



WARNING!

DO NOT exceed your GVWR. Weigh your RV when loaded for travel to determine the actual weight. If the GVWR is exceeded, remove items until your weight is less than or equal to the GVWR.



WARNING!

Overloading your RV will VOID the Limited Base Warranty, Limited Structural Warranty, and the Warranties of many component parts.

Tire Safety

Properly maintained tires improve the steering, stopping, traction, and load-carrying capacity of your vehicle. Under-inflated tires and overloaded vehicles are a major cause of tire failure. Therefore, to avoid flat tires and other types of tire failure, you should maintain proper tire pressure, observe tire and vehicle load limits, avoid road hazards, and regularly inspect your tires.

Tire Fundamentals

Federal law requires tire manufacturers to place standardized information on the sidewalls of all tires. This information identifies and describes the fundamental characteristics of the tire and also provides a tire identification number for safety standard certification and in case of a recall.



CAUTION!

Passenger car tires are not recommended for use on trailers. The capacity rating is not denoted on the sidewalls of passenger tires. In the event a passenger car tire is used, the capacity must be de-rated by 10%.

Spare Tire & Cover

Note that a spare tire and/or spare tire cover are not standard on all models. To help extend the life and look of your spare tire cover, cover the spare tire with a heavy-duty garbage bag before putting on the spare tire cover. This will help keep the spare tire from bleeding through the spare tire cover.



CAUTION!

NHTSA recommends that if your vehicle comes equipped with a full-size spare tire, that it not be used as a replacement for worn tires, except in emergencies such as replacing a flat tire.



WARNING!

Check tire pressures often. Always check pressure when tires are cold. Do not exceed maximum recommended pressure.

Tire Size

To maintain tire safety, purchase new tires that are the same size as the vehicle's original tires, or another size recommended by the manufacturer. Look at the tire information placard, the owner's manual, or the sidewall of the tire you are replacing to find this information. If you have any doubt about the correct size to choose, consult with the tire dealer.

Tire Pressure & Load Limits

Tire information placards and vehicle certification labels contain information on tires and load limits. These labels indicate the vehicle manufacturer's information including:

- Recommended tire size
- Recommended tire inflation pressure
- Vehicle Capacity Weight (VCW- the maximum occupant and cargo weight a vehicle is designed to carry)
- Front and rear Gross Axle Weight Ratings (GAWR- the maximum weight the axle systems are designed to carry)

Both placards and certification labels are permanently attached to the trailer on the forward half of the left side and are easily readable from outside the vehicle without moving any part of the vehicle.



WARNING!

Keep tires properly inflated. Tires may lose air suddenly and/ or catch fire, if driven for long distances or at high speeds while seriously under inflated. Tires could overheat where damage to the vehicle, contents and/or personal injury may occur.

How To Read A Tire Sidewall

Each letter and number in your tire size code refers to specific information. Learn how to read a tire sidewall using the information below.

Tire Size Code



Tire Date Code

Look at the sidewall of your tire - there will be a code following the letters "DOT" - for Department of Transportation. There will be up to 13 characters that give you the information you need to identify your tire and also identify the date of manufacture of your tires.



7-12 Character TIN:

- The first two characters will be a code that represents the assigned plant code for the manufacturer.
- The next one to two characters represent the tire size code.
- The next grouping can be no more than four characters that are designed by the manufacturer with their internal codes for the specific construction of that tire.
- The final four digits, for any tire made since the year 2000, are the tire date code and represent the date of manufacture. The first two digits designate the week of the year the tires were made, and the final two digits are the last two digits of the year of manufacture.

13 Character TIN

- The first grouping consists of three characters that represent the plant code. Recent legislation is transitioning the factory code from two to three characters.
- The second grouping consists of six characters that identify the tire size, tire type, or other significant characteristics of the tire.
- The last four numbers represent the manufacturer's date. The first two numbers indicate the week, while the last two indicate the year.
- The full DOT code is displayed on at least one sidewall of every tire.



INFORMATION!

The DOT Code is used to register your tire with the manufacturer. Registering your tire provides the tire manufacturer with your name and address to be able to contact you in case of a recall.

Speed Rating

The speed rating denotes the speed at which a tire is designed to be driven for extended periods of time.

SPEED RATING	MPH	KM/H
L	75	120
M	81	130
N	87	140
P	93	150
Q	99	160
R	106	170



CAUTION!

It is not recommended to install tires with different speed ratings. If tires with different speed ratings are installed on a vehicle, they should be installed with like pairs on the same axle. The speed capability of the vehicle will become limited to that of the lowest speed rated tires. Obey all speed limits.



INFORMATION!

You may not find this information on all tires because it is not required by law.



CAUTION!

DO NOT exceed the speed rating regardless of the posted maximum speed limit

Load Range & Ply Rating

Load range defines the tire's toughness and maximum allowable air pressure. Each load range letter indicates what ply rating is equivalent in strength. You can locate this information on the sidewall of your tires.

LOAD RANGE	PLY RATING	MAX. LOAD
B	4	35 psi
C	6	50 psi
D	8	65 psi
E	10	80 psi
F	12	95 psi

Load Index & Load Carrying Capacity

Load index indicates the max load a tire can carry. To find your tire's carrying capacity, look for the load index number on the sidewall. The load index number indicates a tire's carrying capacity when inflated to maximum load sustaining pressure.

LOAD INDEX	LBS/ TIRE
100	1,764
101	1,819
102	1,874
103	1,929
104	1,984
105	2,039
106	2,094
107	2,149
108	2,205
109	2,271
110	2,337
111	2,403
112	2,469
113	2,535
114	2,601
115	2,679
116	2,756
117	2,833
118	2,910
119	2,998
120	3,086

Size Specific Specifications

ST225/75R15E

- Speed Rating: N or 87 mph.
- Load Index: 117
- Load Range: E
- Max Load: 2830 lbs.
- Max Inflation Pressure: 80 PSI
- Rim Width: 6 in.
- Section Width: 8.8 in.
- Tread Depth: 8/32nds
- Outside Diameter: 28.3 in.

Tire Pressure & Load Limits

Tire inflation pressure is the level of air in the tire that provides it with load-carrying capacity and affects the overall performance of the vehicle. The tire inflation pressure is a number that indicates the amount of air pressure- measured in pounds per square inch (psi)- a tire requires to be properly inflated. Internationally, the unit of measurement is kilopascal (kPa), which will also be shown on the placard.

Vehicle manufacturers determine this number based on the vehicle's design load limit, that is, the greatest amount of weight a vehicle can safely carry and the vehicle's tire size. The proper tire pressure for your vehicle is referred to as the "recommended cold inflation pressure."

Tires are designed to be used on more than one type of vehicle. Because of this, tire manufacturers list the "maximum permissible inflation pressure" on the tire sidewall. This number is the greatest amount of air pressure that should ever be put in the tire under normal driving conditions.

Checking Tire Pressure

Check your RV's tire pressure at least once a month.

- Tires may naturally lose air over time.
- Tires can lose air suddenly if they come in-contact with sharp or rough objects unexpectedly.
- With radial tires, it is usually not possible to spot under inflation by visual inspection.

Both placards and certification labels are permanently attached to the trailer on the forward half of the left side and are easily readable from outside the vehicle without moving any part of the vehicle.

The recommended tire inflation pressure that vehicle manufacturers provide reflects the proper psi when a tire is cold. The term "cold" is not referring to the outside temperature. Rather, a cold tire is one that has not been driven on for the last three hours. When you drive, your tires get warmer, causing the air pressure within them to increase. Therefore, to get an accurate tire pressure reading, you must measure tire pressure when the tires are cold or compensate for the extra pressure in warm tires.



INFORMATION!

For convenience, purchase a tire pressure gauge to keep in your vehicle. Gauges can be purchased at tire dealerships, auto supply stores, and other retail outlets.

Maintaining Proper Tire Pressure

- Locate the recommended tire pressure on the sidewall of the tire itself.
- Record the tire pressure of all tires.
- If the tire pressure is too high in any of the tires, slowly release air by gently pressing on the tire valve stem with the edge of your tire gauge until you get to the correct tire pressure.
- If the tire pressure is too low, note the difference between the measured tire pressure and the correct tire pressure. These "missing" pounds of pressure are what you will need to add.
- At a service station, add the missing pounds of air pressure to each tire that is under-inflated.
- Check all tires to make sure they have the correct tire pressure recommended on the tire.



CAUTION!

If you have been towing your RV and think a tire may be under-inflated, fill it to the recommended cold inflation pressure indicated on your tire information placard. Your tire may still be slightly under-inflated due to the additional pounds of pressure in the warm tire. It is safer to drive with air pressure that is slightly lower than the vehicle manufacturer's recommended cold inflation pressure than to drive with a significantly under inflated tire. This is a temporary fix. Be sure to recheck and adjust after you obtain a cold tire reading.



WARNING!

Check tire pressures often. Always check pressure when tires are cold. Do not exceed maximum recommended pressure.

Tire Tread

The tire tread provides the gripping action and traction that prevent your vehicle from slipping or sliding, especially when the road is wet or icy. In general, tires are not safe and should be replaced when tread is worn down to 1/16 of an inch. Tires have built-in tread wear indicators that allow you to visually identify when it is time to replace your tires. These indicators are raised sections spaced intermittently in the bottom of the tread grooves. When they appear "even" with the outside of the tread, it is time to replace your tires.

Tread Wear Measurement Test

Insert a penny into your tire's tread groove with Lincoln's head upside down and facing you. If you can see all of the head, your tire tread depth is less than 2/32 inch and it's time to replace your tires.



INFORMATION!

Goodyear suggests checking your tire tread depth every 3,000 mi. (5,000 km) or once it reaches 4/32 inches deep. If your tread depth reads 2/32 inches or less, it's time to replace your tires.

Tire Tread Wear Indicator

You can also use the tire tread wear indicator as another method for how to check your tire tread. You can find the tread wear indicator less than an inch (2/32 of an inch) from the bottom of the tread groove. When the tread wears down to become even with this level, the tire should be replaced.

When to Replace Tires

- **Tread wear bars:** All passenger and light truck tires have at least 6 tread wear bars located in the major tread grooves and spaced equally around the circumference of the tire. The tread wear bars are raised rubber strips, 2/32" in height. When the tread groove is flush with the surface tread, your tires should be replaced.
- **Uneven wear patterns:** This may indicate a vehicle alignment or mechanical issue that needs attention.
- **Bulges or blisters on the tire's sidewall:** These can lead to tire disablement and should be inspected.
- **Low tire pressure:** Flat or severely underinflated tires need to be inspected.
- **Sudden ride disturbance or vibration:** This may be an indication of possible tire damage or a vehicle mechanical issue and should be inspected.

Tips for Replacement

- **Replace all four at once:** Vehicle manufacturers recommend replacing all four tires at the same time to maintain optimum vehicle performance and handling.
- **Install tires on the rear axle:** If only two tires are replaced, install them on the rear axle and move the partially worn tires to the front axle to help maintain control on wet roads.
- **Do not mix sizes, tread patterns, or tire construction.**
- **Different speed ratings:** It's not recommended to fit tires with different speed ratings. However, if they are fitted with different speed ratings they should be installed with like pairs on the same axle.
- **Load-carrying capacity:** Make sure replacement tires have an equal or greater load-carrying capacity to the original equipment tires.

Tire Repair

The proper repair of a punctured tire requires a plug for the hole and a patch for the area inside the tire that surrounds the puncture hole. Punctures through the tread can be repaired if they are not too large, but punctures to the sidewall should not be repaired. Tires must be removed from the rim to be properly inspected before being plugged and patched.

Tire Blowout

The goal in any blowout is to keep the vehicle balanced and controllable. Do not panic. Any overreaction – including slamming on the brakes or abruptly removing your foot from the accelerator – can result in a loss of control over the vehicle. Instead, you should take the following steps:

- Hold the steering wheel with both hands.
- Maintain your vehicle speed if possible and if it's safe to do so.
- Gradually release the accelerator.
- Correct the steering as necessary to stabilize your vehicle and regain control. Look where you want the vehicle to go and steer in that direction.
- Once your vehicle has stabilized, continue to slow down and pull off the road where and when you judge it's safe to do so.



WARNING!

Before working underneath your RV, use jack stands to support both the front and rear axles. Failure to do so may result in serious death or injury.

Note: Hydraulic Jack and Jack Stands are not provided by Winnebago.



CAUTION!

When using bottle-type jacks, a metal plate or block of wood to relieve stress against the steel frame should be inserted between the jack and frame. DO NOT use a bumper jack. It may damage the sidewalls or floorboard of the trailer.

Changing Tires

In the event of a flat tire, follow the steps below to put your spare tire on;

- Turn on the tow vehicle's hazard warning flashers.
- Set up flares or warning lights.
- Chock the opposite tire and unhitch the trailer from the tow vehicle, or eliminate tension on equalizer bars, if applicable.
- Place scissors-type or hydraulic jack on a block of wood directly under the frame, close to the tire you intent to change.
- Raise the jack to take weight off the tire.
- Loosen the lug nuts.
- Raise the jack until the tire clears the ground.
- Remove the lug nuts and old tire. Put the spare tire on the hub.
- Replace and tighten the lug nuts.
- Lower the jack until the tire touches the ground.
- Tighten the lug nuts to a torque of 90 to 95 ft. lbs.
- Lower and remove the jack.
- Hook up equalizer bars, if applicable.
- Check the torque immediately.

Tire Balance and Wheel Alignment

To avoid vibration or shaking of the vehicle when a tire rotates, the tire must be properly balanced. This balance is achieved by positioning weights on the wheel to counterbalance heavy spots on the wheel-and-tire assembly. A wheel alignment adjusts the angles of the wheels so that they are positioned correctly relative to the vehicle's frame. This adjustment maximizes the life of your tires. These adjustments require special equipment and should be performed by a qualified technician.

Wheel Nut Torque Information

It is important to maintain proper torque and to provide safe and secure attachment of the wheel to the hub/drum. Be sure to use wheel nuts that are compatible with the nut seat in the wheel. Improperly torqued wheel nuts can cause the wheel to separate from wheel mounting surface during operation. This could result in property damage, serious personal injury, or loss of life.

1. CLEAN mounting surfaces, LUG NUTS & STUDS. DO NOT LUBE lug joint unless specifically instructed in your owner's manual.
2. START NUTS BY HAND to prevent cross threading.
3. TIGHTEN NUTS IN SEQUENCE shown using a CALIBRATED TORQUE WRENCH. DO NOT USE AN IMPACT WRENCH. Required lug nut torque is 115 ft-lbs + 2 lbs.
4. For new and remounted wheels, RE-TORQUE lug nuts prior to first tow and after the first 50 and 250 miles of driving. Lug nut TORQUE should be CHECKED and RE-TORQUE periodically thereafter as necessary.



CAUTION!

Do not attempt to repair or modify a damaged wheel. Even minor modifications can cause a dangerous failure of the wheel and result in personal injury or death.



NOTICE!

CHECK WHEEL LUGS. On first trip, tighten wheel lugs at start and at 10, 25, and 50 miles. Tighten to manufacturer's specifications. Thereafter, check wheel lugs before each trip, after excessive braking and following winter storage.



CAUTION!

Dexter's patented Torq-N-Go™ swiveling wheel nut generates significantly more clamp load than standard wheel nuts. Do not exceed the specified torque or the wheel and/or stud may be damaged. Special caution should be observed with steel wheels. Some steel center discs may not be able to withstand the Torq-N-Go™ wheel nuts' specified operating torque. It is the responsibility of the trailer manufacturer to assure that its' wheels are compatible with this wheel nut.

Wheel Installation Torque Sequence

Wheel Size	Stud Size	1st Stage	2nd Stage	Final Torque	Cone Nut Degree
12" - 440 BC	1/2"-20	20-25	35-40	60-75	60° Cone Nut
12" - 545 BC	1/2"-20	20-25	35-40	60-75	60° Cone Nut
13" - 440 BC	1/2"-20	20-25	35-40	60-75	60° Cone Nut
13" - 545 BC	1/2"-20	20-25	35-40	60-75	60° Cone Nut
14" - 545 BC	1/2"-20	20-25	50-60	100-120	60° Cone Nut
15" - 545 BC	1/2"-20	20-25	50-60	100-120	60° Cone Nut
15" - 655 BC	1/2"-20	20-25	50-60	100-120	60° Cone Nut
16" - 655 BC	1/2"-20	20-25	50-60	100-120	60° Cone Nut
16" - 865 BC	9/16"-18	20-25	50-60	140-170	60° Cone Nut
16.5" - 655 BC	1/2"-20	20-25	50-60	100-120	60° Cone Nut
16.5" - 865 BC	9/16"-18	20-25	50-60	140-170	60° Cone Nut
16.5" x 9.75" 865 BC	5/8"-18	50-60	120-125	175-225	Special Stud Piloted With 90° Cone Nuts
17.5" Hub Pilot 865 BC	5/8"-18	50-60	100-120	190-210	Hub Piloted With Clamp Ring, 90° Cone Nuts & Greased Threads
17.5" Hub Pilot 865 BC	5/8"-18	50-60	90-200	275-325	Hub Piloted With Flange Nut
17.5" Hub Pilot 865 BC	5/8"-18	50-60	60-110	150-175	Hub Piloted With Swivel Flange Nut

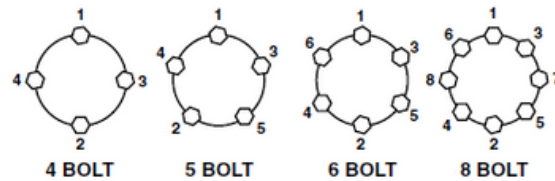

Maximum Wheel Fastener Torque

The wheel mounting studs used on Dexter axles conform to the SAE standards for grade 8. The maximum torque level that can be safely applied to these studs is listed in the following chart:

Stud Size	Maximum Torque
1/2"-20 UNF, class 2A	120 Ft. Lbs.
9/16"-18 UNF, class 2A	170 Ft. Lbs.
5/8"-18 UNF, class 2A	325 Ft. Lbs.



CAUTION!

Exceeding the above listed torque limits can damage studs and/or nuts and lead to eventual fractures and dangerous wheel separation.

Axles & Suspension

Dexter Axles

Most of our travel trailers are equipped with Dexter axles designed for a smoother ride. Spring shackle mounts are welded to the frame of the trailers. Check the shackle bolts periodically for tightness. Do not reuse shackle bolts and nuts, if an axle must be removed. Self-locking nuts must be replaced if removed.

Reading An Axle Label

Sprung and Torflex axle labels can be found on the side of the axle facing your rear bumper. The axle label provides critical manufacturing information, including the axle serial number, axle capacity, and axle build information. Locating your axle label will help ensure that you identify your axle correctly. If you need to replace an axle, please locate the axle label before contacting Dexter.



Identification Features:

1. Customer Part Number or Axle Model Number
2. Axle Configuration Number
3. Axle Model and Capacity (lbs.)
4. Hub Face, Spring Center, Outside of Bracket, and Start Angle
5. Nev-R-Adjust® Callout
6. Serial Number (Barcode)
7. Serial Number (Digits)

Double Eye Leaf Spring Maintenance

All the components of your suspension system should be visually inspected at least every 6,000 miles for signs of excess wear, elongation of bolt holes, and loosening of fasteners. Whenever loose or replaced, the fasteners in your suspension system should be torqued as detailed in the Dexter Complete Service Manual. All wet bolts and equalizers should be greased every 3,000 miles.

TORFLEX Maintenance

Except for periodic inspection of the fasteners used to attach the Torflex axle to the vehicle frame, no other suspension maintenance is required on Torflex axles. They are, of course, subject to the maintenance and inspection procedures regarding brakes, hubs, bearings, seals, wheels, and tires as outlines in the Dexter Complete Service Manual.



CAUTION!

You must follow the maintenance procedures to prevent damage to important structural components. Damage to certain structural components such as wheel bearings can cause the wheel to come off the axle. Loss of a wheel end while the trailer is moving can cause you to lose control and lead to an accident, which can result in serious injury or death.



CAUTION!

Do not lift or support the trailer on any part of the axle or suspension system. Never go under any trailer unless it is properly supported on jack stands which have been rated for the load. Improperly supported vehicles can fall unexpectedly and cause serious injury or death.

**CAUTION!**

DO NOT WELD ON THE TORFLEX BEAM. It has rubber cords inside and the heat generated by welding could damage the cords.

BAL Independent Suspension

Winnebago HIKE 100 and HIKE 100 FLX feature BAL's Independent Suspension with Dexter TORFLEX Torsion Stub Axles. The BAL Independent Suspension Bridge system allows each wheel to travel independently, and features custom-designed coil over shock absorbers that dampen wheel oscillation to keep the trailer level, as well as protect it from travel-related damage. Dexter TORFLEX® stub axles feature four rubber cords with a heat-treated solid steel inner bar that cushions the ride and absorbs road shock, reducing transmission into the chassis and RV. Additional strength and durability are provided by forged heavy-duty hubs, integrated with precision machined steel spindles and cast-iron hub-drums. Equipped with electric brakes and E-Z Lube axle bearings. For more information on care, maintenance, and warranty please refer to the BAL website and support documentation or contact an authorized Winnebago dealer.

Towing & Leveling

Tow Vehicle Specifications

Winnebago Towables travel trailers can be towed by many types of vehicles. When selecting a tow vehicle for travel trailers, complying with vehicle manufacturer specific recommendations concerning towing capabilities and restrictions is critical. Many vehicle manufacturers and dealers can provide specific requirements, such as trailer size, maximum trailer load and tow vehicle demands during travel (i.e., terrain, trip lengths, etc.).

Adhere to Traffic Laws

When towing your Winnebago Travel trailer it is imperative that you adhere to the State and Local traffic laws including;

- Always wear your seatbelt
- Do not exceed the posted speed limit
- Be an alert driver
- Always use daytime running lights to increase visibility
- Never drive when tired
- Never drive under the influence of alcohol, drugs or medication that may affect your ability to safely operate a vehicle
- Be aware of weather conditions

Tow Vehicle Tune-up

Proper vehicle maintenance is necessary including engine tune-ups and lubrication. An engine may overheat on long upgrades, which may be prevented with a larger, heavy-duty radiator and proper care.

Battery & Alternator

During travel, the tow vehicle battery and alternator must support some of the trailer's electrical equipment including taillights, turn signals, brake lights, clearance lights and electric brakes. The battery and alternator must be in good condition and able to handle this load.

Rearview Side-Mounted Mirrors

Rearview, side-mounted mirrors on both the driver and passenger sides of the tow vehicle are a necessity. Side-mounted mirrors provide a clear view of following traffic and an unobstructed view of the trailer action. They should be properly extended offering an unobstructed view of the rear of the trailer and possible traffic hazards. A travel trailer chassis (springs, wheels, tires, axles, frame, and tongue) are engineered to carry a set maximum load.

Electronic Brake Controllers

Many types of electronic brake controllers are available. Consult your dealer to determine specific needs. Insist that any electronic brake controller be installed per the manufacturer's instructions. It may be necessary to install a resistor in the trailer's braking system. If the trailer skids or the brakes grab, a resistor in the circuit may remedy the problem. Follow the individual resistor manufacturer's instructions. Do not use more than one resistor in the circuit.

Power Tongue Jack

Every Winnebago travel trailer is equipped with a Power Tongue Jack. This is an automatic lifting system that raises and lowers the frame of the trailer to help when hitching and unhitching. The Power Tongue Jack requires 12-volt power which is wired at the factory. In the event of a blown fuse or dead batteries, you will need to locate the manual override connection and crank handle that fits into the manual override connection. Simply crank the handle in the appropriate direction to raise or lower your tongue jack. Clockwise will raise the jack, and counterclockwise will retract it. For additional care and maintenance information refer to the supplier information provided in the Red Winnebago Owner's Bag.

Safety Chains

The Department of Transportation federally mandates use of safety chains on travel trailers. Safe towing recommendations include:

- Hook the safety chains to the loops provided on the tow vehicle's hitch
- Cross the chains under the trailer tongue before hooking them
- Leave only enough slack in each length of chain to allow for sharp turns.
- The chains should not drag on the ground.
- When all connections are secure, be certain the 7-Way Trailer Connector Plug and the breakaway switch lanyard cable are longer than the extended safety chains.
- Should the hitch ball become disengaged from the coupler, the safety chains will extend, the 7-pin connector should remain connected to the tow vehicle for braking and the breakaway switch should not engage.

Weight Distribution

Proper weight distribution between the axles and trailer tongue is critical for safe towing. Factors to consider when evaluating proper weight distribution are:

- Tongue proportion of the GROSS VEHICLE WEIGHT should be approximately 10-15% for tandem axle trailers. Depending on the tow vehicle, 11-12% is ideal.
- Proper distribution required for towing stability, assures the trailer is not unproportionate or heavy on the front, rear, or sides.
- A light tongue weight or heavy weight placed at the rear end of the trailer may cause trailer sway.
- Too much weight on the tongue can overload the tow vehicle, and cause poor tow vehicle stability and handling, poor braking, poor cornering and may damage the trailer frame.

Rear Bumper Limitations

The rear bumper of a travel trailer is not intended to be a weight bearing structure. The bumper is not capable of supporting any additional weight beyond that of the tire carrier and spare tire. Besides being unable to support added weight, adding weight to the rear of the travel trailer will affect the hitch weight and the stability of the trailer while towing.



IMPORTANT!

The rear bumper of our travel trailers is not intended to be used as a step and are not designed to support more than 70 pounds.

Breakaway Device

Should your trailer become completely disconnected while being towed, the breakaway device is designed to actuate the trailer brakes and bring it to a stop, preventing a runaway trailer. The switch has a pull pin linked to the tow vehicle with a steel cable; the cable pulls the pin free. This causes two contacts in the device to go together, immediately closing the circuit between the trailer battery and the trailer brakes.

Hitch Connection

Using the proper hitch on the tow vehicle is critical for maximum safety when towing a travel trailer. Load leveling or load-equalizing hitches with anti-sway bars are recommended for added stability and maneuvering.

Several factors need to be considered when selecting the proper hitch, including;

- Gross weight of trailer
- Tongue weight
- A welded or bolted weight-carrying hitch on the frame or body of the tow vehicle
- Hitch ball size: 2 5/16
- Lubricate the hitch ball periodically

Consult your dealer and/ or a representative of your tow vehicle manufacturer in selecting a hitch and accessories for your trailer.

Hitches

Many types and ratings of trailer hitches are available. Important factors when selecting the proper hitch are:

- Follow the tow vehicle manufacturer's and the hitch manufacturer's recommendations to ensure proper installation and size requirements.
- Keep the tow vehicle and the trailer level to maintain equal weight distribution and ensure maximum steering control.
- The Maximum Towing Capacity of your hitch must be greater than your GVWR to avoid unsafe towing.
- The Maximum Hitch Weight for your hitch must be greater than the weight of the hitch you purchase.

It is important to maintain the hitch weight of your travel trailer when loading. You may have to move items around to stay within the safe range of 10-15% of your total GVWR. If your hitch weight is too heavy, move items towards the back of your unit. If your hitch weight is too light, move items towards the front of your unit.

Hitch Height

For each Winnebago travel trailer, we denote the hitch height on our specifications sheet. Please refer to the website for the most up-to-date specifications. If you would like to check the exact height of your trailer's hitch begin with leveling your trailer. Once the trailer is level and hitched to the loaded travel trailer, use a tape measure to measure the distance from the center of the hitch ball to the ground.

- When a hitch is installed too high, it will transfer weight behind the axles and cause fishtailing while towing
- When a hitch is installed too low, it will transfer weight to the hitch and could be unsafe if over your Max Hitch Weight.

Weight Distribution Hitch

Depending on your tow vehicle, the weight of your travel trailer may cause the back of your vehicle to sag down, or appear to "squat". This is due to improper weight distribution. Weight Distribution Hitches can be purchased to help level out your vehicle and trailer. The hitch uses two steel arms that stick out from under the ball of the hitch and attach to the tongue of the trailer. This allows 25% of the tongue weight to be distributed to the front axles of the tow vehicle, and 25% to the back axles of the trailer. Leveling out both the tow vehicle and trailer allowing for safer towing.

- This does not technically reduce the trailer's tongue weight. Never use a hitch that isn't rated for the entire tongue weight of your trailer.

Sway Control

Sway can be caused by road conditions, wind, speed, tire pressure, tongue weight, or improper weight distribution. Sway bars and hitches can help prevent your trailer from swinging side to side while towing. They use friction to keep your trailer steady. These are aftermarket accessories that can be purchased and installed on your unit. We suggest consulting with your dealer to be sure you purchase the correct one for your tow vehicle and trailer.

Hitching Up

Secure for Travel

Before starting out, make certain everything is secure in the trailer.

- Check cabinets and drawers; make sure items in cabinets and fridge are securely stowed and will not spill.
- Ensure the refrigerator latch is engaged.
- Lock windows and roof guards.
- Close roof vents.
- Secure loose chairs and other items.
- Disconnect all hoses and other items.
- Make sure electrical cords and adapters have been disconnected and put away.

Vehicle & Trailer Hookup

To safely hookup your travel trailer to your tow vehicle, follow the following procedure:

- Leave your wheel chocks in place until you have completed the entire hitching procedure.
- Check the Power Tongue Jack to ensure it is hookup up to 12-volt power. Raise or Lower the Tongue Jack using the rocker switch until the travel trailer tongue is above the tow vehicle's hitch ball.
- Open the coupler latch on the travel trailer hitch.
- Check to make sure the area is clear, then back the tow vehicle until the vehicle hitch is just under the travel trailer coupler.
- Lower the Tongue Jack using the rocker switch to lower the trailer coupler on top of the tow vehicles hitch ball.
- Close the couple latch and securely fasten the safety pin.
- Fully retract the Tongue Jack.

- Verify that all four Power Stabilizer Jacks are fully retracted.
- Attach the breakaway switch cable to the tow vehicle.
- Cross and attach the safety chains to the tow vehicle.
- Plug in the 7-Way Trailer Connector Plug to the tow vehicle. Secure the connection. Verify the connection works by turning on the trailer lights or stepping on the brakes.
- Remove the wheel chocks.



WARNING!

NEVER allow anyone to go under the RV while it is being lifted and/or towed.



WARNING!

DO NOT overextend or retract the power tongue jack as that could cause damage which would not be warrantable.



WARNING!

Both the power tongue jack and the power stabilizer jacks must be fully retracted before moving or towing the RV to prevent damage.



IMPORTANT!

DO NOT allow anyone to ride inside your travel trailer as a passenger while driving. This is illegal in multiple states.



CAUTION!

Never tow a trailer without the trailer battery being hooked up and fully charged. Attach the breakaway lanyard cable so it is longer than the safety chain. When connected to the vehicle, the pull on the pin is in a straight line with the cable. Do not hook the cable over the trailer ball.

7-Way Trailer Connector Plug

The 7-pin connector on the trailer hitch transfers 12-volt DC electrical power from the tow vehicle battery to the trailer brakes, exterior lighting system, and battery. After hitch connections have been made, the 7-pin connector must be longer than the extended safety chains.

- Keep the plug clean, tight, and protected from the elements.
- Inspect the plugs carefully every time you hitch up.
- Always connect a 10 gauge, stranded, insulated copper "charge line" from the alternator on the tow vehicle to the trailer's 12-volt connector. The "charge line" will keep the trailer battery charged while traveling.
- A 30-Amp circuit protector should be installed near the alternator connection.

Trailer End

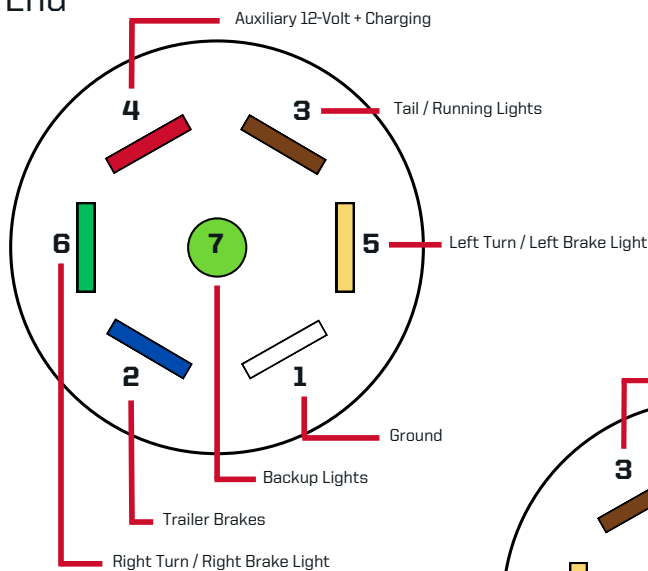

Truck End

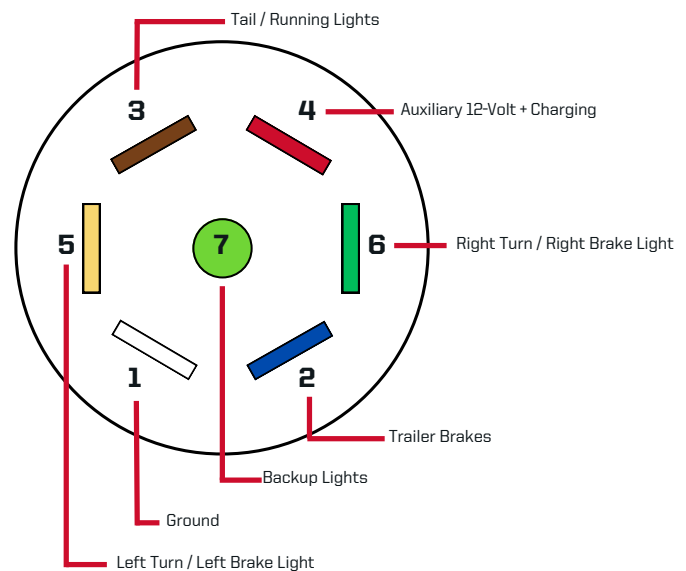

Brake System Components

Tow Vehicle Battery

The primary power source for the trailer braking system is the tow vehicle battery. The connection is made at the positive post of the battery or at the tow vehicle starter solenoid battery terminal.

Brake Controller

NOTE: Brake Controller's are not supplied by the manufacturer, they must be supplied by the customer after purchasing the unit. Brake Controller's are recommended to work in unison with the RV Electric trailer brakes. Electric trailer brakes are automatically applied by the brake controller, which is usually mounted within easy reach of the driver. Connect an electric brake controller to the brakes with 12-gauge stranded wire. Some controllers are connected to the tow vehicle's hydraulic brake system and are actuated when tow vehicle brakes are applied. Other information about brake controllers:

- Most experienced drivers prefer the trailer brakes to be set to engage slightly before the tow vehicle brakes.
- During rainy weather or slippery road conditions, if the tow vehicle brakes first, the trailer will tend to push the tow vehicle or possibly "jackknife".
- Lag time can be adjusted by turning the brake controller knob. The new setting will be retained until a new adjustment is made.
- Brake controllers usually have a manual feature, allowing the trailer brakes to be applied independently of the tow vehicle brakes.
- Consult instructions supplied with the controller for further information.

Battery Isolator

NOTE: Battery Isolator's are not supplied by the manufacturer, they must be supplied by the customer after purchasing the unit.

A Battery Isolator is a device that utilizes currents from the tow vehicle alternator to charge both the RV battery and the tow vehicle battery. This prevents the RV from draining your tow vehicle battery.

Braking Tips

Never use the trailer brakes alone for extended periods.

- They were designed to stop the trailer, not the tow vehicle.
- Such use places excessive loads on the brakes causing overheating, fading, and premature wear of magnets, brake shoe linings, and drums.
- Driving control is adversely affected when tow vehicle brakes are used alone, due to the force of the trailer pushing against the tow vehicle. This is especially true on slippery pavement or loose gravel, and jackknifing can occur.

Always use the automatic brake controller.

- The synchronized braking system enables safe driving with both hands on the steering wheel.
- If the brake controller is properly adjusted, there will be a slight "lead" on the trailer brakes. This braking resistance, combined with the tow vehicle's engine pulling power, helps keep the two vehicles correctly aligned and help bring them to a safe, straight stop.

**WARNING!**

Do not install a fuse in the circuit between the tow vehicle battery and an electric or electronic brake controller. A blown fuse would cause the controller to cease functioning, causing trailer braking loss with no advanced warning. Circuit protection should be installed per the brake controller manufacturer's instructions.

Breakaway Switch

This device is a vital component of the trailer's braking system. The breakaway switch is located on the trailer A-frame. The basic concept of a breakaway switch is:

- A steel cable (lanyard) is fastened to the switch, which should connect to the frame of the tow vehicle.
- When connected to the tow vehicle frame, the lanyard cable should be longer than the extended safety chains.
- It automatically applies the trailer brakes if the tow vehicle and trailer become uncoupled while in motion.
- The breakaway switch operates when a pull pin linked by a cable to the tow vehicle separates from the switch.
- As the switch closes, the trailer battery supplies power to apply the brakes.
- The steel lanyard must be anchored to the tow vehicle when the trailer is hitched. Secure this cable loop to the permanent frame of the tow vehicle, or a non-removable part of the hitch.
- Do not fasten the breakaway switch lanyard to the hitch ball or any other removable part of the hitch.
- Be sure to install an auxiliary battery to provide power to the breakaway switch.

**IMPORTANT!**

SAFETY BREAK-AWAY SWITCH WILL NOT OPERATE unless connected to a power source equivalent to or greater than an automotive type 12 volt, 12 amp hour wet-cell battery.

Breakaway Switch Care

Remove the pull pin every 3 months and lubricate with light oil. Before reinserting the pin, spray the inside of the switch with an electrical contact cleaner to prevent corrosion.

**WARNING!**

DO NOT tow a trailer with a malfunctioning breakaway switch.

**WARNING!**

DO NOT USE THE BREAKAWAY SWITCH FOR A PARKING BRAKE.

Breakaway Switch Test

Test the breakaway switch operation before each trip by following the steps below:

- Hitch the trailer to the tow vehicle.
- Pull out the pull in.
- Test the breaker by attempting to drive away. If the breakaway switch is functioning properly, the trailer brakes will be activated.
- If the brakes are not activated, check to make sure that the trailer battery is connected and full charged, and the trailer brakes are properly adjusted.
- If the trailer brakes do not operate after making these checks, contact your dealer to schedule a repair.
- Reinsert the pull pin before towing the trailer.

**WARNING!**

DO NOT LEAVE THE PULL PIN OUT OF THE BREAKAWAY SWITCH FOR MORE THAN A FEW MINUTES, OR THE BATTERY WILL BE DRAINED.

Trailer Brakes

Travel trailer brakes are actuated by 12-volt electrical energy, converted to mechanical energy, providing power for smooth, safe stops. Greater electrical current from the brake controller will provide greater braking force applied to the trailer brake drums.

Grounding

Only proper grounding back to the tow vehicle can complete the 12-volt electrical circuit within a travel trailer brake system. A poor ground circuit from the brakes to the tow vehicle battery can be as detrimental to efficient braking as a poor primary circuit from the battery to the brakes. Do not rely on the hitch ball and coupler for a good ground. Run a ground in the 12-volt connector to the tow vehicle battery negative post or the tow vehicles frame. The ground conductor must be the same wire size as the "charge line".

Brake Inspection & Adjustment

Complete the following inspections before using the travel trailer.

- Inspect all external braking system components.
- Inspect all wiring connections and test the breakaway switch as outlined previously.
- Inspect the brake drums and internal components each time the wheel bearings are repacked.
- The magnets and linings should not show excessive or uneven wear. The magnets should move freely on their mounts.

After replacing the hubs on an axle, adjust the brakes using a standard automotive brake tool:

- Remove the rubber plug from the adjustment hole at the base of the brake drum backing plate.
- Raise the wheel off the ground. Place the jack under the axle only.
- With the adjusting tool, turn the adjusting screw while spinning the wheel. When the wheel begins to drag heavily, back off the screw just enough for the wheel to spin freely.
- Replace the adjustment hole plug. Lower the wheel, remove the jack and repeat the sequence for the other wheels.

Parking & Leveling

Tips

Park on a wide, level spot whenever possible, never on a steep slope. Leveling is necessary for comfort and for correct operation of your refrigerator, water system drainage, and monitor panels.

Procedures

- Choose a site that is as level as possible, some sites are equipped with a prepared surface such as concrete or asphalt). Ensure the ground is not soft and will support the weight of power stabilization jacks and/or other support devices.
- Place vehicle in park and turn off ignition before exiting the vehicle.
- Place wheel chocks to prevent the RV from moving once disconnected.
- Unhook the 7-Way Trailer Connector Plug and breakaway switch cable. Place on the trailer's frame out of the way.
- Unhook both chains, uncross them, and attach them to the trailer's frame out of the way.
- Using the Power Tongue Jack, raise the trailer high enough to open the tongue jack coupler latch and release the hitch ball.
- Move the tow vehicle forward, or to an out of the way area.
- Level the RV front-to-rear with the power tongue jack.
- Use a small level in the refrigerator, and on the countertop or floor to confirm the trailer is level.
- Lower all four stabilizing jacks until they are engaged. Be sure all four jacks have approximately the same pressure to avoid causing the unit to twist. Doing so can cause slideouts, doors, etc., to bind and/or operate intermittently.

Side-to-Side Leveling

To level the trailer from side to side:

- Use a step ramp- customer provided.
- Place the step ramp under the wheels on the low side of the trailer.
- Use a bubble level to determine when the trailer is level.

Front-to-Rear Leveling

To level the trailer from front to rear:

- Block the wheels so that the trailer cannot roll.
- Uncouple the trailer from the tow vehicle.
- Level the trailer front to rear, with the Power Tongue Jack.
- Power stabilization jacks should be used to support the trailer after leveling from front to rear.



WARNING!

DO NOT attempt to lift the RV with either the stabilizer jacks or power tongue jack. These jacks are NOT designed to bear the total weight of the RV, Stabilizer jacks are only to help steady the trailer from movement.

Stabilizing Jacks

All Winnebago Travel trailers are equipped with power stabilization jacks. They each have independent power switches allowing each to extend or retract to the exact needed height. Stabilizer jacks are meant to stabilize the front and rear of the unit while parked.

DO NOT attempt to lift the unit with the stabilizer jacks. These are not designed to bear weight, only to help stabilize the unit from movement. Please refer to the manufacturer's instructions supplied with the unit for care and operation.

Appliance Information

Self- Contained vs. Utility Hookup

Travel trailers are designed to be self-sufficient in remote campsites. Carefully watch water reserves, propane gas, battery power, holding tank capacity, tow vehicle battery power and gasoline.

The following chart shows the source of power or supply for various trailer components depending on whether you are setup for self-contained operation or at a RV park hookup.

Self- Contained

If you plan to go off-the-grid in your new travel trailer, read below to learn where your trailer gains power for each item within;

- Range/ Oven: LPG
- Water Heater: LPG
- Furnace: LPG
- Refrigerator: LPG
- Furnace Blower: 12-volt trailer battery
- Motor: 12-volt trailer battery
- Vent Hood: 12-volt trailer battery
- Wall Electrical: N/A
- Outlets: 12-Volt trailer battery
- Interior Lights: 12-volt trailer battery
- Air Conditioning: N/A
- Water Supply: Trailer Water Tank
- Water Pressure: 12-volt pump on demand
- Drainage-Kit: Gray holding tank
- Lavatory sink: Gray holding tank
- Tub/ Shower drainage: Gray holding tank
- Toilet: Black holding tank
- Trailer battery: Tow vehicle
- Recharge: Alternator
- Lights (Brakes signal, backup, running brakes): 12-volt tow vehicle battery
- Brakes: 12-volt tow vehicle battery
- Safety device: 12-volt tow vehicle battery



CAUTION!

Before using your appliances please read and understand the manufacturer owner manual for each specific component found in your Red Winnebago Owner's bag.

Microwave

The microwave may vary depending on both the model and floorplan you purchase.

- Ensure there is sufficient 120-volt power available before attempting to operate.
- Ensure the turntable is secured before travelling to prevent injuries or damage.

Microwave Convection Oven

The microwave may vary depending on both the model and floorplan you purchase.

- Microwave Convection Oven's operate on 120-volt power.
- Please refer to the manufacturer's instructions supplied with the unit for care and operation.

Oven

The oven may vary depending on both the model and floorplan you purchase. The oven can be used for general baking. It requires propane gas and some models require a pilot to be lit while other light electronically using 12-volt power. Please refer to the manufacturer's instructions supplied with the unit for care and operation.

- We recommend you DO NOT use the oven as a storage area.

Range Hood

The range hood has both a light and fan control switch on the front panel. Refer to component manual for proper use. The range hood operates on 12-volt power and should be used to ventilate when cooking. Please refer to the manufacturer's instructions supplied with the unit for care and operation.



DANGER!

Do not use gas cooking appliances for comfort heating. Can lead to carbon monoxide poisoning, which can lead to death or serious injury.



WARNING!

Gas cooking appliances need fresh air for safe operation. Before operating:

Open vents or windows slightly or turn on exhaust fan prior to using cooking appliance. Gas flames consume oxygen, which should be replaced to ensure proper combustion. Improper use can result in death or serious injury.

Range Top with Oven

For optimal safety, refer to the component manufacturer manual and follow recommended flat bottom pan size. Failure to do so may result in the ignition of clothing from an undersized pan. An oversized pan, covering multiple burners, may result in melting due to excessive heat.

**WARNING!**

DO NOT turn on the gas range burner controls and allow propane gas to escape before lighting.

**WARNING!**

Do not operate this appliance unless the privacy curtain is secured away from the appliance or removed. Can cause a fire, which could result in death or serious injury.

Refrigerator

The refrigerator can operate on 120-volt or on LP gas (requires 12-volt to light). The unit must be level to operate properly. The refrigerator will operate most efficiently when:

- The unit is level.
- It is allowed 4 hours to cool prior to putting items in it.
- The items are already cold or frozen before placing them in the refrigerator.

Powered Patio Awning

If equipped, this awning can be extended and retracted electronically. This awning may or may not have a tilt function. Awnings without tilt functionality will need to be stored during rain. For awnings equipped with a tilt function, during rain, it will be necessary to tilt one end of the awning for proper water run-off and/ or store the awning. Please refer to the awning manufacturer's instructions supplied with the unit for care and operation.



IMPORTANT!

Damage to the awning due to wind, rain, or any weather condition is NOT covered under warranty by Winnebago or the awning manufacturer.

Manual Batwing Awning

All Winnebago Hike 100 and Hike 100 FLX travel trailers are equipped with a manual batwing awning. This awning will arrive inside the unit in a box. Inside the box are the components that make up the batwing awning. This being a manual awning, you will need to put this awning up and take it back down before moving your unit or resuming travel. For additional information please contact an authorized Winnebago dealer.

Portable Induction Cooktop

All Winnebago Hike 100 and Hike 100 FLX travel trailers are equipped with a Portable Induction Cooktop instead of a stationary range. Practice caution when operating. Do not leave the cooktop on and unattended for any period of time. This can be used to cook inside or outside of your unit. Practice caution when choosing which surface to set the induction cooktop on to operate. For additional information refer to the manufacturer's manual.

Outdoor Kitchen

Some Winnebago travel trailers are equipped with an outdoor kitchen with a griddle cooktop. Practice caution when operating this cooktop. Refer to the manufacturer's manual for additional information.



WARNING!

When using this outdoor cooking area, the vehicle must be level and stabilized. Do not violate manufacturers' instructions on required clearances for cooking appliances during use. Do not store cooking appliances until cool to the touch. Can lead to a fire and explosion and result in death or serious injury.

**DANGER!**

All pilot lights, appliances, and their igniters (see operating instructions) shall be turned off before refueling offuel tanks and/ or propane containers. Failure to comply could result in death or serious injury.

**DANGER!**

Do not store combustible material in this area. Can cause a fire, which could result in death or serious injury.

**DANGER!**

IF YOU SMELL PROPANE:

1. Extinguish any open flames and all smoking materials.
2. Shut off the propane supply at the container valve(s) or propane supply connection.
3. Do not touch electrical switches.
4. Open doors and other ventilating openings.
5. Leave the area until the odor clears.
6. Have the propane system checked and leakage source corrected before using again.

Ignition of flammable vapors could lead to a fire or explosion and result in death or serious injury.

**WARNING!**

DO NOT use portable fuel burning equipment (for example; grills or stoves) inside your RV. Use of these items inside an RV may cause fires or inability to breathe.

Carbon Monoxide

CO Detector

For your safety, a carbon monoxide (CO) detector is installed in every unit. Depending on the model it may be operated by battery (9- volt , AA) or wired so that it will be powered by an RV battery (if equipped) or 12-Volt power from the converter. Please refer to the manufacturer instructions supplied with the unit for care and operation at www.atwoodmobile.com or www.mtiindustries.com.

Common Sources

Common sources of CO are malfunctioning or misuse of gas appliances, vehicle engines, generators, and many other fuel burning products.

Indications of Poisoning

Some indications of CO poisoning include, but are not limited to, the following:

Mild Exposure:

- Flu like symptoms without a fever, Slight headache, Dizziness, or Fatigue

Medium Exposure:

- Severe throbbing headache, Drowsiness, Confusion, or Fast heart rate

Extreme Exposure:

- Unconsciousness, Convulsions, Cardiorespiratory failure, Death



DANGER!

If the alarm sounds, exit the vehicle immediately. The CO buildup may dissipate before help arrives but may be only temporarily solved. It is crucial that the source of the CO is determined and repaired.



DANGER!

Gasoline generators and LP generators and appliances produce carbon monoxide. Carbon monoxide can be fatal! When the device detects carbon monoxide in the air, it will sound. Consult the user manual of the individual detector for specific instructions and/ or audible warning meanings.



WARNING!

Test smoke alarm operation after vehicle has been in storage, before each trip, and at least once per week during use. Failure to do so can result in death or serious injury.

Maintenance

For your safety and to keep your carbon monoxide alarm in good working order, follow the steps below:

- Verify the unit alarm, lights, and battery operation by pushing the "Test" button weekly.
- Vacuum the CO alarm cover with a soft brush attachment once a month to remove accumulated dust.
- Instruct children never to play with CO alarm. Warn children of the dangers of carbon monoxide poisoning.
- Never use detergents or solvents to clean the carbon monoxide alarm.
- Avoid spraying paint, hair spray, air fresheners or other aerosols near the CO detector.
- Do not paint the CO detector. paint will seal the vents and interfere with the sensor ability to detect CO.
- Do not place a diaper pail nearby.
- Test the alarm operation after your RV has been in storage, before each trip, and at least once a week during the camping season.
- Replace the CO detector when recommended by the manufacturer, which is typically every 5 years.

Heating & Cooling

Furnace

The furnace is a propane gas appliance that requires 12-volt power to electronically light. New furnaces sometimes emit smoke and an odor during the first 5 - 10 minutes of initial use due to paint burning off the heating chamber. Do not mistake this for a malfunctioning furnace. Please refer to the manufacturer's instructions supplied with the unit for care and operation.



DANGER!

All pilot lights, appliances, and their igniters (see operating instructions) shall be turned off before refueling off fuel tanks and/ or propane containers. Failure to comply could result in death or serious injury.



DANGER!

Do not store combustible material in this area. Can cause a fire, which could result in death or serious injury.

Thermostat- Wall Mounted

If your unit is equipped, a wall mounted thermostat can be for furnace only or a combination of air conditioning and furnace. Please refer to the manufacturer's instructions supplied with the unit for care and operation.

Roof Vents

If equipped, a powered ceiling fan runs on 12-volt. this equipment is an excellent tool to help manage indoor air quality. Please refer to the manufacturer's instructions supplied with the unit for care and operation.

Air Conditioner

For those units equipped with roof mounted air conditioners, they operate on 110-volt AC power. There are different sizes and variations available depending on the unit. An air conditioner takes a sizeable amount of power to run. Most RV electrical systems are designed with 30 amps of available power with some having 50-amp capability. It may be necessary to reduce other loads when using air conditioning to reduce the change of overload and possibly tripping the main breaker.

In climates that experience high temperatures, a second air conditioner may be necessary to maintain a comfortable indoor temperature on larger trailers. A second air conditioner requires 50-amp service. Please refer to the manufacturer's instructions supplied with the unit for care and operation.

Truma Aventa A/C

Winnebago FLX travel trailers are equipped with a Truma Aventa Air Conditioner. This air conditioner run's off of 12-volt power converted to 110-volt using the FLX inverter. For care, maintenance, and troubleshooting refer to the manufacturer's instructions supplied with the A/C.

Fireplace

Some Winnebago travel trailers are equipped with a fireplace. For care, maintenance, and troubleshooting refer to the manufacturer's instructions supplied with the fireplace.

Propane System

Propane

Propane, also known as LP or, liquefied petroleum, is used to operate your range, oven, furnace, water heater, and as an alternate energy source for some refrigerators. Propane has a very distinct smell. This rotten egg smell is added to the propane to allow customers to identify a leak as quickly as possible. With proper handling precautions, propane gas is safe and provides modern conveniences. It is stored as a liquid under pressure and vaporizes under the control of a pressure regulator.

The propane system includes the propane cylinders, propane regulator, hoses, piping and copper tubing lines to each gas appliance. Follow the manufacturer's instructions for each propane appliance and all safety precautions. To avoid trouble, maintain the system regularly.



WARNING!

This propane piping system is designed for use with propane only. Do not connect natural gas to this system. Securely cap inlet when not connected for use. After turning on propane, except after normal cylinder replacement, test propane piping and connections to appliances for leakage with soapy water or bubble solution. Do not use products that contain ammonia or chlorine to test for leaks. Can lead to a fire or explosion, which could result in death or serious injury.

Propane Precautions

- Inspect the entire propane gas system for leaks or damaged parts before each trip.
- Always be careful when drilling holes or fastening objects to the trailer. Ensure a gas line is not punctured by a nail or a screw.
- Do not restrict access to propane tanks. The tank service valve must be accessible in an emergency.
- Do not carry or store filled or empty propane gas containers inside a trailer.
- Propane gas containers are equipped with a safety device that relieves excessive pressure by discharging gas to the atmosphere.
- Leaks can occur at valves and fittings.
- Always store propane tanks with the valves closed
- Do not use any propane gas tanks other than those furnished with the trailer without being sure that all connecting components are compatible.
- Never check for leaks with an open flame. Use an approved leak detection solution or a non-ammoniated, monochlorinated soap solution only. If the leak cannot be located, take unit to a propane gas service representative.
- Propane gas regulators must always be installed with the diaphragm vent facing downward. Make sure that the regulator vent faces downward and that the cover is kept in place to minimize vent blockage which could result in excessive gas pressure causing a fire or explosion.
- Do not use a wrench or pliers to close the service valve. This valve is designed to be closed, leak-tight by hand. If a tool is required to stop a leak, the valve needs repair or replacement. Contact your dealer.
- Use a proper wrench to tighten the fitting. Don't force, jam, or cross-thread the fitting. Always check this fitting for leaks and tightening.
- Be sure the tanks are securely fastened in their rack whenever they are mounted on the trailer.
- If you do not have the special tools and training necessary, do not attempt to repair propane gas system components.

If You Smell Propane

1. Extinguish any open flames and all smoking materials.
2. Shut off the propane supply at the container valve(s) or propane supply connection.
3. Do not touch electrical switches.
4. Open doors and other ventilating openings.
5. Leave the area until the odor clears.
6. Have the propane system checked and leakage source corrected before using again.

Ignition of flammable vapors could lead to a fire or explosion and result in death or serious injury.



DANGER!

FAILURE TO COMPLY COULD RESULT IN EXPLOSION RESULTING IN DEATH OR SERIOUS INJURY.



WARNING!

Turn off the propane gas main valve and individually turn off all gas appliances or disconnect electric automatic ignition appliances before entering a propane gas bulk plant or motor fuel service station.



WARNING!

Turn off all pilot lights and applications individually before fueling fuel tanks and/ or permanently mounted propane gas containers. When not individually turned off, automatic ignition appliances may continue to spark when propane gas is turned off at the container.

Propane Tanks

While under pressure in the tank, propane gas is compressed into its liquid form. When you use propane to operate appliances, the fuel turns into a gas form. Propane tanks are used to store and deliver gas. They are filled by weight, which is expressed in pounds. To fill propane tanks, a qualified propane facility is required. The tanks will need to be removed from the RV before filling.

When not using the tank, keep the main shut off valve closed. Do not use tools when hand tightening the tank after filling. This is one way to prevent damage to the seal.



IMPORTANT!

Propane EXPANDS 1.5% for every 10 degree increase in temperature. There must be sufficient space inside the tank during the warmer months to allow for gas expansion.

Safety Regulations

As required by the National Fire Prevention Association and the American National Standards Institute. The information and warnings found on the next page may also be found in other sections of this Owner's Manual.



WARNING!

Propane gas containers shall not be placed or stored inside the vehicle. Propane gas containers are equipped with safety devices which relieve excessive pressure by discharging gas to the atmosphere.



WARNING!

DO NOT FILL PROPANE CONTAINER(S) TO MORE THAN 80% OF CAPACITY. FAILURE TO COMPLY COULD RESULT IN A FIRE OR PERSONAL INJURY.

THE WARNING LABEL ABOVE CAN BE FOUND NEAR THE PROPANE GAS CONTAINER.



WARNING!

THIS CYLINDER IS EQUIPPED WITH AN OVERFILL PREVENTION DEVICE.

Propane Gas Regulator

The regulator is the heart of the propane gas system. It works continuously and requires more care and attention than any other part of the system.

When not using the tank, keep the main shut off valve closed. Do not use tools when hand tightening the tank after filling. This is one way to prevent damage to the seal



WARNING!

Do not attempt to adjust the regulator. It has been preset by the regulator manufacturer. If any adjustment is required, it must be made by a qualified LPG servicing technician using special equipment.

QCC1 Coupler

The QCC1 coupler and hose assembly connects the propane gas tanks to the propane gas regulator.

- It has a right-hand thread. Turn it to the right to tighten, turn left to loosen.
- The mating surfaces are brass and do not require any type of pipe sealant.
- If it ever leaks or cannot be reasonably tightened without excessive force, replace the complete hose assembly and/ or have the tank valve checked and serviced.
- The QCC1 coupler contains an excess flow control to help restrict gas flow if the hose is cut or the regulator is broken.
- It is not designed to detect a leak or totally shut off the system if leak or regulator failure occurs.
- The excess flow control can inadvertently restrict gas flow to the appliances. To reduce or eliminate this problem, try the following whenever restricted gas flow is evident:
- Ensure all appliances (including pilot lights, if equipped) are off and no gas is flowing through the system.
- Check for leaks.
- Test the fittings as outlined later in this section.

- Open the gas tank valve slowly. DO NOT SNAP IT OPEN. The sudden pressure fluctuation could confuse the excess flow control into thinking that the system was damaged.
- Wait at least 15 seconds before lighting any pilot or appliance.

This procedure will allow the excess flow control to settle and supply a normal flow of gas.

Lighting Propane Appliances

Detailed operating information for propane appliances can be found in the Owner's Information Package. Please read and follow these instructions. Air trapped in the gas lines may delay initial lighting of any appliance. Several seconds or minutes may pass for the gas to reach the appliance. To purge some of the air from the gas system, first light a burner on the range. The other appliances will then light more quickly.

Filling Propane Cylinder

- Only qualified individuals are permitted to fill this cylinder.
- Read and understand the cylinder warning label before attempting to fill.
- The Overfill Prevention Device (OPD) will only operate if the cylinder is overfilled (greater than 80% level). Do not attempt to calibrate or tamper with the OPD.
- Before filling, inspect the cylinder in accordance with CGA C-6 or CGA C-63.
- The cylinder must be level, stable, and vertical at all times.
- This cylinder must be filled in accordance with US DOT, NFPA-58, State and Local regulations.



WARNING!

Do not fill propane container(s) to more than 80 percent of capacity. A properly filled container contains approximately 80 percent of its volume a liquid propane. Overfilling the propane container(s) can result in uncontrolled propane flow, which could lead to a fire or explosion and result in death or serious injury.

**DANGER!**

FAILURE TO PROPERLY FILL THE CYLINDER CAN RESULT IN INJURY OR DEATH.

Propane Leak Test

ALWAYS test for leaks with a solution of dish soap and water.

- Apply the solution with a spray bottle, to the outside of all gas line joints and fittings.
- If a leak is present, the soapy solution will bubble at the leak point.
- As a general rule, small bubbles indicate a small leak while large bubbles indicate a larger leak.
- NEVER use a solution containing ammonia or chlorine when locating leaks.
- These products are corrosive to copper gas lines and brass fittings, which could result in deterioration of the copper and brass components.

If a leak is not fixed by tightening the connection, shut OFF the propane system valve(s) and immediately contact your dealer or a qualified propane service representative.

**WARNING!**

DO NOT check for leaks using products that contain ammonia or chlorine; these products can cause cracks to form on the metal tubing and brass fittings.

**WARNING!**

If you suspect your propane container has been overfilled, contact your dealer or a qualified propane technician for assistance immediately.

DO NOT use or attempt to service an overfilled propane container yourself.

**DANGER!**

Extinguish all flames. Never use an open flame to check for leaks. Failure to follow this warning could result in a fire or explosion resulting in serious injury or death.

Installing Propane Tanks

The position of the propane tank(s) and hoses is critical for proper operation and propane flow. Follow these instructions to make sure your propane container(s) are connected properly.

- Ensure ALL RV appliances are OFF.
- Check that each LP cylinder Shut-Off Valve is closed.
- Place the LP Tanks on the A-Frame of the trailer and secure them.
- Two 3/8" low-pressure hoses should be attached, one on each side of the auto changeover regulator.
- Check to make sure the regulator is mounted on the housing and the vent is pointing down. This must be unobstructed at all times (Be sure to check after bad weather.)
- Attach the TYPE 1 end of each hose to each LP cylinder.
- Attach the main supply hose from the regulator to the brass manifold fitting in the frame of the trailer. The swivel brass nut on the main hose will be your final attachment.

After Every Tank Removal

Listed below are important items to remember and check after each time the propane tank is removed.

- Check to ensure ALL fittings are tight
- Check to ensure ALL connections are not leaking by using a soapy water solution or Propane Leak Detector.
- Open the main shut-off valve on the LP cylinder very slowly. This avoids propane freeze up, caused by a fast rush of propane to the excess flow valve.

Electrical Systems

12-Volt Chassis Electrical

A trailer chassis electrical system includes:

- Trailer battery
- Charging system
- Battery Disconnect Switch
- Brake system
- Tail lights
- Turn signals
- 12-volt convenience outlets
- 12-volt power vents
- Fans
- Motors
- Freshwater pump
- Any 12-volt entertainment equipment
- All 12-volt interior lighting fixtures
- Other vehicle lights and accessories

The tow vehicle's 12-volt battery, the trailer's 12-volt battery or the AC/DC power converter may provide 12-volt power. The battery's charge is maintained by the tow vehicle alternator, or by the charging circuit included in the power converter.

12-Volt Fuse Block Panel

The 12-volt fuse block panel for DC circuits is located in a cabinet of your RV. The specific location is dependent on your model. Fuses are automotive type and should also be replaced with the same type and amperage rating. Replace bulbs with the same type or equivalent.

12-Volt Circuit Breaker & Reset

In all units, 30-amp circuit breakers are factory installed to protect the trailer's 12-volt electrical system. The circuit breaker is located inside a covered junction box attached inside the front cross member of the A-frame. Additional circuit breakers may be used for slideout switch protection.



WARNING!

DO NOT INSTALL 12-VOLT FUSES WITH AMPERAGE RATINGS GREATER THAN THAT SPECIFIED ON THE FUSE BOX LABEL.



IMPORTANT!

Not all 30-amp circuit breakers are equipped with the reset switch. Resets on 30-amp circuit breakers for slideout motors are automatic reset switches.



WARNING!

THIS CONNECTION IS FOR 110-125 VOLT AC, 60 HZ 30 AMPERE SUPPLY. DO NOT EXCEED CIRCUIT RATING. EXCEEDING THE CIRCUIT RATING CAN CAUSE A FIRE AND RESULT IN DEATH OR SERIOUS INJURY.

110-Volt AC System

The 110-volt AC system provides grounded electrical service for the refrigerator and optional appliances such as air conditioners, microwave ovens, water heaters, TV's, etc. Other appliances such as toasters, and lamps may also operate on the 110-volt system.

The 110-volt system also provides a power source for the power converter. The trailer is equipped with a heavy-duty power cord to connect to an external 110-volt, 30-amp rated AC service. Some units have an optional 110-volt, 50-amp service.

- The cord and connector are molded together to form a weatherproof cable assembly.
- Do not cut or alter the cable in any way.
- Do not remove the cable connector ground pin or bypass the ground circuit of the trailer.
- Be sure the ground is maintained if an adapter is used to plug into an electrical service.
- Do not use a two-conductor extension cord, or any cord or cable that does not assure appropriate and adequate ground continuity.
- NEVER plug the 110-volt cord into an ungrounded receptacle.



WARNING!

DO NOT OPERATE THE 110-VOLT ELECTRICAL SYSTEM WITHOUT A PROPER GROUND.



WARNING!

THIS CONNECTION IS FOR 208Y/120-VOLT OR 120/240-VOLT, 3-POLE, 4-WIRE, 60 HZ, 50 AMPERE SUPPLY. DO NOT EXCEED CIRCUIT RATING. EXCEEDING THE CIRCUIT RATING CAN CAUSE A FIRE AND RESULT IN DEATH OR SERIOUS INJURY.

The Power Converter

The power converter is the nerve center of the 12-volt DC and the 110-volt AC systems.

- The power center will supply 12-volt requirements when operating on 110-volt AC.
- The onboard battery will gradually be brought to a full charge and maintained by the 6-amp battery charger if 110-volt power is available.
- The propane leak detector and other 12-volt components continually consume small amounts of current even when switched "OFF". The trailer's battery will fully discharge within 72 hours if not recharged during that period or if the power center is not connected to a 110-volt AC source.

Battery Disconnect Switch

The Battery Disconnect switch is typically located in an enclosed exterior compartment. The style of the disconnect switch may vary per model. This switch does not shut off all power but is designed to shut off the 12-volt DC power to the main 12-volt fuse panel, and the interior of the RV. Batteries can still be trickle charged by the converter and there will still be power to some devices. When the switch is "ON" there will be a green area showing and "ON" on the switch. To turn the switch "OFF" you will need to turn the dial counterclockwise until you see the red area along the left side of the switch showing "OFF".



WARNING!

DISCONNECT THE BATTERY IF YOU ARE NOT USING YOUR TRAILER.



Ground Fault Interrupter

Kitchen, bathroom, and patio 110-volt electrical outlets are protected by a Ground Fault Interrupter (GFI). This device is provided in compliance with ANSI A119.2/NFPA501C requirements and is intended to protect against hazards of line to ground electric faults and electrical leakage shocks possible when using electrical appliances in the bathroom or damp area.

- Insulation materials for appliances and devices can deteriorate over time to develop cracks allowing electric current to "leak" through insulation.
- Should a circuit or appliance (electric shaver, hair dryer, etc.) develop shock hazard of this type, the GFI device will disconnect the outlet (and other outlets on the same circuit), limiting exposure to current leakage to ground.
- The GFI device does not prevent electric shock, nor does it protect a person who touches both "hot" and neutral sides to the circuit. It does not protect against electrical circuit overloads.

GFI Testing

Test the GFI at least once a month while operating on 110-volt AC.

To test the GFI:

- Push the "TEST" button. The "RESET" button should pop out, indicating that the protected circuit has been disconnected.
- If the "RESET" button does not pop out when the "TEST" button is pushed, a loss of ground fault protection is indicated. DO NOT use the outlet or other outlets on the same circuit.
- Have the trailer electrical system checked at an authorized service center or by a qualified electrician.
- DO NOT use the system until the problem has been corrected.
- To restore power, push the "RESET" button.

200 Watt Go Power! Overlander Solar Kit

All Winnebago travel trailers are equipped with at least 1 200-watt solar panel and 30-amp charge controller. The solar panel converts the sun's energy into DC electricity and this electricity charges the battery. The battery stores the electricity, similar to a water tank storing water. This battery power may be used at any time to operate DC powered devices connected to the battery. To increase the battery service life, a solar controller is used to prevent the solar panels from overcharging the batteries. This process is managed by the 30-amp charge controller.

Inspection

All modules, electrical and mechanical components and connections should be inspected annually by a trained Go Power! or dealer representative or other qualified personnel for safe electrical and mechanical connections and to ensure modules are corrosion-free and vehicle mounting has not affected connections.

Cleaning

- Clean the solar panels monthly. Use water and a soft sponge or cloth. A mild non-abrasive cleanser can be used for more stubborn residue. Rinse well.
- Clean solar panels more frequently during drier months, as they may become covered in dust more quickly. A pressure washer is not recommended.
- Visual inspection - check the exterior for cracks, missing or broken hardware or other potential problems. Check all roof penetrations and replace sealant areas as required

Long Term Storage

In Cold Climates (temps below 32F)

- Cover your solar panels with a protective material that does not allow light to pass through.
- Label your solar panel wires 'positive' and 'negative'
- Unhook your solar panels from your solar controller
- Fix wire nuts on the positive and negative leads from the solar panels
Disconnect your batteries and store them inside in a warm, dry place preferably off the floor on something like a wooden pallet. (AGMs can handle temps lower than 20F)
- Check the batteries monthly and charge them if necessary.

In Warm Climates

There is no need to 'store' your RV solar system in warm climates unless your RV is parked indoors or in very low sunlight. If that's the case, simply follow the cold climate storage directions above.

However, do make sure that all parasitic draws are removed from the batteries i.e. Propane detector, clock radio, etc to make sure the solar panel(s) can keep the batteries topped up even with reduced sun exposure.

Side Mount Solar Prep

Every Winnebago travel trailer is pre-wired for an additional solar panel. This allows you to decide if you would like to add additional solar to your unit. If you choose to add an additional solar panel, consult with your dealer to ensure you purchase a panel that will operate correctly with your system.

Tire Pressure Monitoring System Prep

All Winnebago travel trailers excluding the Hike Series are pre-wired with a Tire Linc repeater dock. This allows installation to be toolbox-free. Simply, plug your repeater into the dock, screw the sensors onto your tire valves, and connect your OneControl app. Once you have the app, set the recommended pressure and temperature ranges for each tire sensor, so your system knows when to alert you of changes. These sensors update your tire status several times each minute when you're driving and every 15 minutes when parked.



IMPORTANT!

Look for this icon in the App Store or Google Play to download the Lippert OneControl App.



Voyager Backup Camera Prep

Some Winnebago travel trailers are pre-wired for a Voyager backup camera. This allows you to plug and play with the camera of your choosing from Voyager. Please refer to their website and support documents for care, maintenance, and installation.

All-in-One Control Panel

All Winnebago travel trailers are equipped with an all-in-one control panel. This allows you to control your slideouts, awning, lights, tank pad heaters, and monitor your tanks to know when to fill or dump them.

12-Volt Tank Pad Heaters

All Winnebago travel trailers are equipped with 12-volt tank pad heaters with an interior switch. These pads are on every tank to ensure in cold weather your tanks do not freeze. Our goal is to allow you to extend your camping season. For care and maintenance please see an authorized Winnebago dealer.

USB/ USBC Charge Ports

All Winnebago travel trailers are equipped with USB and USBC charge ports. This allows you to easily charge your electronics without taking up multiple outlets. For care and maintenance please contact an authorized Winnebago dealer.

WiFi Prep

All Winnebago travel trailers are pre-wired with King OmniGO HD Television Antenna and prepped to easily add King Wi-Fi Range Extenders, King LTE Cell Boosters, or King Satellite Antennas. For more information please contact an authorized Winnebago dealer.

Xantrex Freedom XC Pro 3,000-Watt Inverter

All Winnebago FLX travel trailers are equipped with a 3,000 watt pure sine wave inverter. True sine wave 120 Vac inverter with built-in transfer switch. Monitor and operate using the Xantrex control panel installed in your unit, or download the Xantrex Control App. Features:

- Monitor and configure via Bluetooth app on iOS and Android
- Full rated performance in all climate temperatures
- True sine wave output for sensitive and motor loads
- Ignition control turns inverter off when ignition key is off
- Extended surge rating, surges to 2x continuous power for 2 seconds for motor loads

What can be powered:

- Laptop
- TV
- Blender
- Fridge
- Microwave
- Iron
- Coffee Maker

For more information about use, troubleshooting, maintenance, or warranty please refer to the Xantrex support documents or reach out to an authorized Winnebago dealer.



IMPORTANT!

Look for this icon in the App Store or Google Play to download the FXC Control App.



Lithionics 320-Amp-hour Lithium-Ion Battery

All Winnebago FLX travel trailers are equipped with a 320-amp-hour Lithium-Ion battery. To operate the Lithionics system use the control panel or download the Lithionics Battery Monitor app. Storing your battery at the correct specifications is important as it keeps the battery in the healthiest state possible for the fastest deployment when needed.

- If your battery has the Lithionics Internal Heater, and you are subject to winter conditions, keep the battery ON, solar ON and plugged into shore power. Shut down all appliances, lights, and other DC loads. Purchase a Lithionics Battery (KF Series), This will keep the heater running and protect your battery, eliminating the procedures below.
- If shore power or the use of an extension cord and charge is not possible, follow these notes below, observing the important storage times versus temperature conditions. Storage outside of these temperatures reduces battery life:

Storage Temperature & Humidity Range	< 1 Month	-4 to 95F (-20 to 35C), 45 to 75% RH
	< 3 Months	14 to 86F (-10 to 30C), 45 to 75% RH
	3 to 6 Months	>32F (0C) Above Freezing, <86F (30C)

Short Term Storage: Up to 3 months:

- Fully charge the battery. Record and maintain the storage VOLTAGE reading (not SoC%) for your warranty.
- Turn the battery OFF by the On/Off/Storage switch. If you have an external BMS, it is preferred to fully disconnect the BMS from the MODULE by pulling apart the Anderson EURO DIN connector.
- Keep the battery in an environment according to the specifications shown above.

Long Term Storage: >3 Months and 6 Months Maximum

- Reduce the battery SOC to 3.3V/cell which is 50% \pm 10% SOC.
- Turn the battery OFF via the On/Off/Storage switch. If you have an EXTERNAL BMS, we suggest you disconnect the BMS from the module or modules by pulling apart the large Anderson EURO DIN connector.
- Storage Temperature: the battery must be maintained ABOVE freezing temperatures (>32F/0C)
- Every 6 months, you must charge the battery to 100% SOC, then discharge the battery to RVC, then charge it back to 50% \pm 10% SOC. This cycle from full to reserve then up to the storage VOLTAGE is important for long life.

For more information on care, maintenance, and warranty refer to the manufacturer's manual.



IMPORTANT!

Look for this icon in the App Store or Google Play to download the Lithionics Battery Monitor app.



Plumbing System

Fresh Water System

The Fresh Water System consists of the Fresh Water holding tank, connections, the water heater, water pump, faucets, shower, exterior showers, and spray ports. Before your first use be sure to sanitize the Fresh Water system. All Winnebago travel trailers are winterized during the manufacturing process.

Filling with A Gravity Fill

This water storage tank is filled through a gravity filler cap outside the vehicle, if equipped.

- Before filling the tank, turn the pump switch to "OFF".
- Open the filler cap on the outside of the trailer.
- Pour the water in from a bucket or use a hose.
- When the tank is full, close the cap before turning the pump switch to "ON".

Filling without A Gravity Fill

- Connect a garden hose to the city water connection located on the docking station.
- Turn the selector valve to the tank fill location.
- Do not turn the water pump to the "ON" position.
- Turn on the water supply line and the tank will begin to fill.
- Please do not walk away from the RV while the tank is being filled.
- Once the tank is filled, turn the water supply "OFF".
- Turn the water valve to System Use position. At this setting your water pump will draw water from the Fresh water tank when needed.



CAUTION!

Overfilling the fresh water tank from a pressurized source may cause serious damage to the water tank or structural components. monitor water tank filling continuously.



Fresh Water Gravity Fill Inlet



City Water Inlet

City Water

Water, under pressure, is provided when the trailer is connected to a park or city water supply. Connect the trailer as follows:

- Turn the 12-volt water pump to "OFF"
- Remove the protective cap on the city water fill and connect a hose between the city water supply and the city water fill on the trailer.
- An in-line 60 psi pressure regulator is recommended to protect the trailer's water system.
- Open the city water supply valve.
- Open the faucets in the trailer and let the water run a few minutes to clear the lines.



IMPORTANT!

If the water system is hooked up to a city water supply, the onboard storage tank and the 12-volt pump are isolated from the system. Do not turn the pump to "ON" until the city water supply is disconnected to avoid damage to the pump.

Fresh Water System Sanitizing

Sanitize the fresh water tank and piping at least once a year or after taking the RV out of storage/winterization. This will discourage the growth of bacteria and other organisms that can contaminate the water supply. Follow these steps to sanitize the Fresh Water System:

- Close all drains and check to make sure drain plugs are installed
- Check how many gallons of water the Fresh Water Tank holds
- The sanitizing solution is made of 1/4 cup of bleach for every 15 gallons of water
- Mix the amount of bleach needed with 1 gallon of water
- Use a funnel to pour the solution into the Fresh Water system
- Fill the Fresh Water Tank completely using a hose
- Turn "ON" the Water Pump
- Open all hot/cold faucets, including the shower, exterior shower, and spray ports until you smell bleach
- Turn "OFF" Water Pump
- Close all faucets
- Let this solution sit in the tank for at least 24-hours
- After 24 hours, drain all water
- Refill with potable water
- Turn "ON" Water Pump
- Open all hot/cold faucets, including the shower, exterior shower, and spray ports until you no longer smell bleach
- Repeat this process until the bleach smell is gone



WARNING!

Potable water only. Sanitize, flush, and drain water tank before using. Failure to maintain tank can result in death or serious injury.



CAUTION!

DO NOT run the water pump without water in the system. Always keep the pump switch "OFF" when the system is empty or when connected to the city water. Running the water pump dry can damage it and void the warranty.

Drain the Fresh Water System

- Before draining the Fresh Water system, follow the steps outlined previously to dump the Black and Grey Tanks
- Clear the water pump line
 - Turn on the water pump
 - Place a bucket in the sink to avoid water entering the Gray Water tank
 - Open the sink faucet
 - Allow the water from the Fresh Water tank and pump to drain
 - This may take around 30 seconds
 - The faucet may spit air as it empties, this may last a few minutes
 - Once water is cleared, turn off the water pump
- Drain the Low Point Drain Valves
 - Open both Low Point Drain Valves located on the outside of the RV on the underbelly
 - You may need to reach far under the RV to open these
 - Open faucets to allow air into the system to help drain
- Drain Water Heater Tank
 - Open Pressure Release Valve on the water heater located on the outside sidewall of your unit
 - This will allow the water to drain from the Water Heater Tank
 - Remove Water Heater Tank Valve
- Blowout City Water Inlet
 - Keep the Low Point Valves Open
 - Close the faucets
 - Attach the Air Compressor Blowout Plug to the City Water Connection
 - This Plug allows one end to attach to the City Water Inlet and the other to the Air Compressor
 - Apply low pressure, around 20lbs psi, using an Air Compressor for several seconds
 - This will clear the remaining water in the City Water Inlet
 - Remove Air Compressor Blowout Plug and replace the inlet cap

Holding Tanks & Draining System

Travel trailers are equipped with two or three separate holding tanks to accommodate waste. One holding tank accommodates toilet drainage. The tub/shower and sinks have a separate draining system. Both systems terminate at the waste valves outside the trailer.

Black Water Holding Tank

Proper toilet instruction and maintenance is explained in the manufacturer's manual supplied with the toilet.

- The toilet operation is designed to minimize the use of water needed to flush it.
- It is advisable to instruct children and guests of proper toilet use to avoid unnecessary damage.

Before using the Black Water holding tank, prime the tank with five (5) gallons of water to discourage waste solids from settling directly under the flush valve. Add a holding tank chemical (available from your local RV supplier). Follow instructions on the package. If required, an antifreeze solution can be added at this time. It will not harm the plastic holding tank material. The holding tanks will more effectively drain solids when the tank is relatively full of fluids. When the blackwater tank is ready to be emptied, locate a proper disposal station to prepare for drainage.



IMPORTANT!

After draining the holding tank, a false reading may sometimes occur on your monitor panel due to debris or tissue hanging on the sensor probes in the tank. Most debris clinging to the monitor probes will dislodge during travel by maintaining holding tank fluid levels of at least 1/3 capacity.



CAUTION!

Do NOT use any chemical additive that is not approved for recreational vehicle use. Consult your dealer for any clarification.

Grey Water Holding Tank

The sinks and tub/shower wastewater will drain to a separate holding tank. This holding tank will be referred to as the Grey Water holding tank.

Emptying Black & Grey Tanks

- Supplies Needed:
 - Gloves
 - Sanitizing Wipes
 - Black Tank Flush Hose
 - Sewer Hose
- Put on gloves
- Connect the Sewer Hose to the Black tank outlet (RV Side) and to the dump station drain
 - Open the Black tank valve
 - Allow the tank to drain into the drain
- While draining the Black tank,
 - Use a sanitizing wipe to wipe off the Non-potable water dump station hose
 - Connect the Black Tank Flush Hose to the Non-Potable water at the dump station hose
 - Connect this hose to the black tank flush
 - This may be on the opposite side of the RV
 - Turn the dump station water on to begin flushing the Black Water system
- Once the system is flushed, turn off the water flushing hose, and close the Black Tank drain valve
- Move the Sewer Hose to the Grey Tank outlet
 - Some models may only have a Black Tank outlet, if so leave the Sewer Hose attached and open the Grey Water valve
- Disconnect the Black Water tank flush hose
- Once the Grey Water tank is drained, close the valve and disconnect the sewer hose from the RV
- Leave the Sewer Hose attached to the dump station drain, use the dump station hose to spray out the Sewer House
 - It is important to always drain the Black Water Tank before the Grey Water Tank, the Grey Water begins to clean the Sewer Hose while draining
- Remove gloves and dispose of any trash
- Sanitize hands and leave the dump station
- Add water to the toilet and add a tank treatment
 - This allows the tanks to be treated while traveling



WARNING!

Holding tanks are enclosed sewer systems and must be drained into an approved dump station. All holding tanks must be drained and thoroughly rinsed regularly to prevent accumulation of harmful toxic material.



IMPORTANT!

DON'T put facial tissues, paper, automotive type antifreeze, sanitary napkins, household toilet cleaners, or any other foreign objects in your holding tank which may clog or damage the system.

Cassette Toilet

All Hike 100 and Hike 100 FLX travel trailers are equipped with a cassette toilet in place of the black water holding tank. With a cassette toilet, instead of the waste going into your black tank, it enters a small, portable waste tank. You can remove this waste tank, and dump it in a public restroom. For more information contact an authorized Winnebago dealer.

Showermiser Water Reclamation

All Winnebago FLX travel trailers are equipped with a Showermiser water reclamation system. This valve reroutes the water as it heats up to avoid clean water going to your gray tank. Once the water is hot, the valve changes from blue to blue with white strips. For more information contact an authorized Winnebago dealer.

Truma AquaGo Water Heater

All Winnebago FLX travel trailers are equipped with a Truma AquaGO Water Heater. This provides instant hot water. For more information on care, maintenance, and warranty refer to the manufacturer's manual or reach out to an authorized Winnebago dealer.

Water Heater

The Water Heater is designed to provide hot water to your sinks, showers, and spray ports. The temperature is preset by the manufacturer. For specific information on care, maintenance and troubleshooting refer to the support documentation provided with your unit.

Water Heater Bypass

The water heated bypass is located at the back of the water heater, this location may vary depending on the units floorplan. There are three (3) valves, the cold water line bypass valve, the mixer or middle valve, and the hot water line bypass valve.

During normal camping set the valves to the "Normal Use" position shown in the diagram below. This allows cold water to enter and hot water to exit.

When Winterizing or Sanitizing the Fresh Water System, turn the water heater bypass valves to the "Bypass" position show in the diagram below. This prevents Anti-freeze from entering the water heater.



CAUTION!

Keep drain valve closed to minimize the presence of sewer gases. Sewer gases can be present when RV is connected to campground sewage hookup. Can lead to illness or personal injury.



CAUTION!

Do not use the tank flush valve unless the tank termination valve is in the open position. Can result in an unsanitary condition leading to illness or personal injury.



IMPORTANT!

Remove the waterless trap before using mechanical drain - cleaning devise. Waterless trap can be damaged.

Winterization Process

**THIS UNIT HAS
BEEN WINTERIZED**

When to Winterize

It is important to winterize your travel trailer if the weather will be at or below 32 degrees Fahrenheit (0 degrees Celsius). When your camping season is over, be sure to winterize your travel trailer before storing it for winter.

Supplies Needed

- Air compressor- 20lbs psi
- Air compressor blowout plug
- 2-3 gallons of RV, food safe, pink Antifreeze
- Phillips and flat head screwdriver
- Water buckets
- Towels

Drain the Fresh Water System

- Before draining the Fresh Water system, follow the steps outlined previously to dump the Black and Grey Tanks
- Clear the water pump line
 - Turn on the water pump
 - Place a bucket in the sink to avoid water entering the Gray Water tank
 - Open the sink faucet
 - Allow the water from the Fresh Water tank and pump to drain
 - This may take around 30 seconds
 - The faucet may spit air as it empties, this may last a few minutes
 - Once water is cleared, turn off the water pump

- Drain the Low Point Drain Valves
 - Open both Low Point Drain Valves located on the outside of the RV on the underbelly
 - You may need to reach far under the RV to open these
 - Open faucets to allow air into the system to help drain
- Drain Water Heater Tank
 - Open Pressure Release Valve on the water heater located on the outside sidewall of your unit
 - This will allow the water to drain from the Water Heater Tank
 - Remove Water Heater Tank Valve
- Blowout City Water Inlet
 - Keep the Low Point Valves Open
 - Close the faucets
 - Attach the Air Compressor Blowout Plug to the City Water Connection
 - This Plug allows one end to attach to the City Water Inlet and the other to the Air Compressor
 - Apply low pressure, around 20lbs psi, using an Air Compressor for several seconds
 - This will clear the remaining water in the City Water Inlet
 - Remove Air Compressor Blowout Plug and replace the inlet cap
- Blowout Black Tank Inlet
 - Keep the Low Point Valves Open
 - Close the faucets
 - Attach the Air Compressor Blowout Plug to the Black Tank Connection
 - Apply low pressure, around 20lbs psi, using an Air Compressor for several seconds
 - This removes any water remaining in the interior lines of the black tank
 - Remove Air Compressor Blowout Plug and replace the inlet cap

Winterizing with Antifreeze

- Locate interior panel covering Water Heater Tank
 - Remove the panel
 - Place panel and screws in a safe location
 - Turn the Water Heater Tank Bypass Valves to the "Bypass" position as shown in the diagram below
 - It is important to complete this step to avoid Antifreeze in the Water Heater

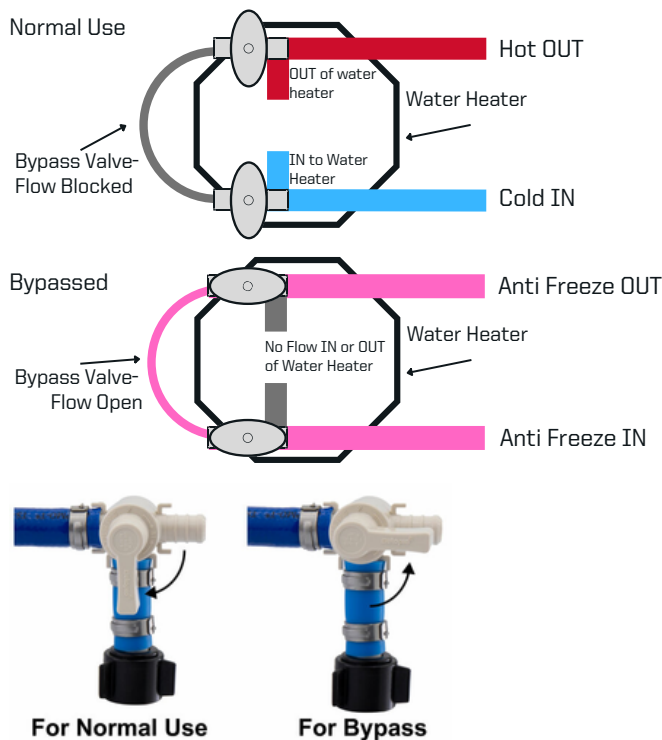

NOTE: For Normal Use: Position the valve handles towards the water heater for normal usage.
 For Bypass: Position the valve handles towards the inlet/outlet pipes for winterizing usage.

- Locate interior panel cover the Water Pump
 - If you aren't sure where the panel is located, turn on the Water Pump for a moment to locate the Pump by sound
 - Turn off once the panel is located
 - Remove interior panel
 - Place panel and screws in a safe location

- Locate the attached siphon hose
 - If Water Pump is not equipped with a siphon hose, locate the Fresh Water Intake Line, disconnect from the water pump and replace with a siphon hose. There may be a clip that loosens to allow easy exchange of these lines
- Get 1 gallon of Antifreeze, place the bottle into a bucket to avoid spills.
- Put the siphon hose into the bottle
- Turn on the Water Pump
- Verify the low point drains are draining pink antifreeze
- Quickly close both low point drains once confirmed to avoid wasting Antifreeze
- Turn Water Pump on and open each interior faucet, confirming both the hot and cold knobs are draining Antifreeze
- Turn on the shower faucet and shower head, confirming both hot and cold knobs are draining Antifreeze
- Flush the toilet until the water is pink, leave some Antifreeze in the bottom of the toilet.
- This helps prevent the drain valve from drying out
- Turn on exterior shower, exterior kitchen faucets, and exterior spray ports until Antifreeze runs through. Make sure to turn on both hot and cold knobs.
- Pull the siphon house out of the Antifreeze bottle just enough that it cannot intake any new Antifreeze
- Turn on the Water Pump and open a faucet until Antifreeze is sucked out of the siphon, you may need to hold the hose up to get all
- Put a towel on the floor by the Water Pump, lay the siphon house on top of the towel to catch any leftover Antifreeze
- Remove towel
- Turn off the power to the Water Pump
- Pour Antifreeze into the P-traps in the sinks, and shower tub
- Remove smoke detector batteries, leave the smoke detector battery cover open to serve as a reminder to replace the batteries before use

Entertainment Systems

The following is an overview of the factory-installed entertainment electronics. For more detailed information please refer to the manufacturer's user guides included in your red Winnebago bag.

Tv Antenna

To watch local stations, turn ON both the TV and TV Antenna. To receive best TV reception, point the antenna toward the nearest signal transmitter. Ensure the area around the antenna is clear of any electrical wires or other obstructions. Before moving the unit, be sure to stow the antenna properly.



DANGER!

DO NOT raise TV antenna near overhead electrical wires as contact may cause injury or death.

TV Booster

The booster will be typically located near one of the TV locations and has a switch to turn it on and off. The booster is designed to amplify the TV "air" signal. The booster must be turned ON to improve TV antenna reception. The TV Booster sends 12-volt DC power to the TV antenna which boosts the signal, then carries the boosted signal through a cable to the internal antenna.

Satellite

If equipped, please refer to the manufacturer's instructions supplied with the unit for care and operation. When selecting your campsite, make sure you have a clear line of site (no obstruction from trees, etc.) to the southwest so you can obtain the satellite signal.

TV

If equipped, please refer to the manufacturer's instructions included in the unit for care and operation. The typical operation temperature range for LCD TV is 41 degrees Fahrenheit (5 degrees Celsius) to 104 degrees Fahrenheit (40 degrees Celsius). Please refer to the manufacturer's instructions supplied with the unit for care and operation.

Entertainment Center & Speakers

If equipped, please refer to the manufacturer's instructions included in the unit for care and operation.

Furniture & Soft Goods

Blinds & Pleated Shades

Operating Instructions:

- Shades should be opened or closed by pushing the bottom rail up or pulling down with the knobs provided. For a duplex (day/night) shade or free-floating shade, move only one rail at a time. Shades should remain up when not in use to aid pleat retention. If tension adjustments become necessary, simply wind cords around center of the bobbin fastener to tighten or retie to loosen. Any adjustments should be made equally on both cords for shade to remain level. Rubbing cords with paraffin wax (or candle) will help lengthen the life of the cords by reducing friction and fraying.

Cleaning Instructions:

- Dry brush or vacuum only. Pleated shades should not get wet. Use a damp cloth with mild soap to remove small stains.

Draperies & Bedspreads

Draperies and upholstery fabrics are treated with fire-retardants and are dry-clean only unless the manufacturer label indicates otherwise. When dry cleaning, be sure to inform attendant of fire-retardant items. Spots and stains should be removed with a non-water based commercial spot remover manufactured for this purpose. Washing a dry-clean only bedspread could cause premature deterioration, fading, shrinkage and/or possible damage.

DO NOT ATTEMPT TO DRY OR FLUFF BEDSPREADS OR DRAPERIES IN A DRYER. THE BACKING MATERIAL WILL MELT WHEN EXPOSED TO CONUAL HEAT. Professional cleaning will preserve the finishes and appearance of these products.

Fabrics & Upholstery

Do not laundry upholstery fabrics. Blot up stains promptly and use an upholstery cleaner or mild solvent, depending on the stain. Never soak the fabric and use as little water as possible. Blot rather than rub. Towel dry or have professionally cleaned. Upholstery can be vacuumed regularly using a soft brush attachment.

Carpeting

The carpeting installed is made of nylon and is easy to maintain. Vacuum regularly to remove abrasive grit. Water-based spills and spots should be removed immediately with a damp cloth. Grease or oil-based stains and spots should be spot cleaned with a good commercial spot cleaner made for this purpose. If complete shampooing is desired, it is best to have it done by a component professional carpet cleaner. Never soak or waterlog your carpeting.

Fabric Color Fading

The minimum light fastness for home furnishings is 40 hours of direct sunlight. In addition, drapery fabrics are affected by gas fading; the upholstery wallboards and carpeting emit a gas and in extreme heat can cause fading. Sun fading/ gas fading is not a warranty item. When storing vehicle, it is suggested to avoid direct sun and keep ventilated to avoid heat buildup.



CAUTION!

Bed should be in down position before travel.

Dream Dinette

The Dream Dinette allows for quick and easy dinette table-to-bed conversion. For additional information, reach out to an authorized Winnebago dealer.



U-Shaped Dinette

Some floorplans are equipped with a U-shaped Dinette which has a removable table instead of a Dream Dinette. The table can be removed and placed to form a bed. The dinette cushions convert into a bed or lounge area. See below for photos:



Dinette Setup



Lounge Setup



Bed Setup



Bed Setup

Slide-Out System

Slide-Out Room

Many Winnebago travel trailers are equipped with a slide-out room to maximize your living space. Before operating the slideout make sure the trailer is level and stabilized. Also ensure you have sufficient power.

Opening the Slide-Out

- Level the trailer and put the stabilizer jacks down.
- Allow sufficient space for room movement.
- Check for obstructions on the roof and at the ends of the slide-out room (i.e., close any open cabinet doors that may be in the way).
- Press and hold the lower rocker switch to open.
- As the room reaches the wall, stop pressing the switch.
- Check the perimeter seal behind the wood trim. If the perimeter seal is not in contact with the room, very briefly press the rocker switch to further open the room until the seal makes contact. For the perimeter seal to be effective, the slide-out must be completely extended.
- You may hear noises as you open the slide-out, this is normal.



CAUTION!

Continuing to press the slide-out room rocker switch will cause the top of the room to run past the perimeter seal. Damage to the wood trim around the slideout room and damage to the interior walls may occur if the room is run out beyond the perimeter seal.



IMPORTANT!

Ensure that the RV is level before operating the slide-out. Water leaks and other problems could result from the slide-out being operated without leveling the RV.

Closing the Slide-Out

- Clear the roof of any debris (i.e., leaves, branches, etc.).
- Check for obstructions insider (i.e., open doors, drawers, rugs, furniture, etc.).
- Press and hold the upper rocker switch to close the room. Block stops have been placed on the gear rails to stop the slide-out room at the proper closed position.
- As the gear mechanism begins straining to close further, remove pressure from the rocker switch and inspect the outside bulb seal. The outside bulb seal will be compressed to half its open thickness when closed properly.

Slide-Out Maintenance

- Keep the battery at full charge. A low battery will affect slide-out room operation.
- At least twice a year, open the slide-out room and inspect the drive rams. Remove any dirt and grime accumulations. Apply a light coating of white lithium grease to the drive rams if needed.
- Check all bolts attaching the rams to the bottom of the slide-out room.
- Spray rubber seals with silicone to maintain flexibility.

Manually Operating Slide-Out

Main Slide-out Rooms: Access to the manual drive shaft for flush floor and non-flush floor slides is located on the opposite side of the slide-out room, between the skirt metal and main rail of the frame. To operate manual drive shaft, a 3/4" socket is required.



CAUTION!

Before manually operating the slide-out, be sure the power switch is turned off.

Schwintek In-Wall Slide-Out

Some Winnebago travel trailers are equipped with a Schwintek In-Wall Slide-out. If problems extending or retracting the slideout occur, please follow these steps to override the system.

Prior to Operation

- Unit should be parked on the most level surface available.
- Leveling or stabilizing system should be actuated to make sure unit will not move during operation of slide-out system. Note: In the case of a motorized unit, ignition must be off to operate the slide-out.
- Make sure to keep all persons and pets clear of slide-out system during operation. Note: Install transit bars (if so equipped) on the slide-out room during storage and transportation.

Extending Slide- Out Room

- Level the unit
- Remove the transit bars (if so equipped).
- Press and hold the IN/OUT switch in the OUT (Fig. 1B) position until the room is fully extended and stops moving. Note: It is important to continue to press the slide-out switch for a few seconds after the room is fully extended until the motor shuts off. The control will sense that the room has stopped and will shut off the motor after a few seconds.
- Release the switch, which will lock the room into position.

Retracting Slide- Out Room

- Press and hold the IN/OUT switch in the IN position until the room is fully retracted and stops moving.
 - Note: It is important to continue to press the slide-out switch for a few seconds after the room is fully retracted until the motor shuts off. The control will sense that the room has stopped and will shut off the motor after a few seconds.
- Release the switch, which will lock the room into position.
- Install the transit bars (if so equipped).

Slide-Out Assembly Diagram

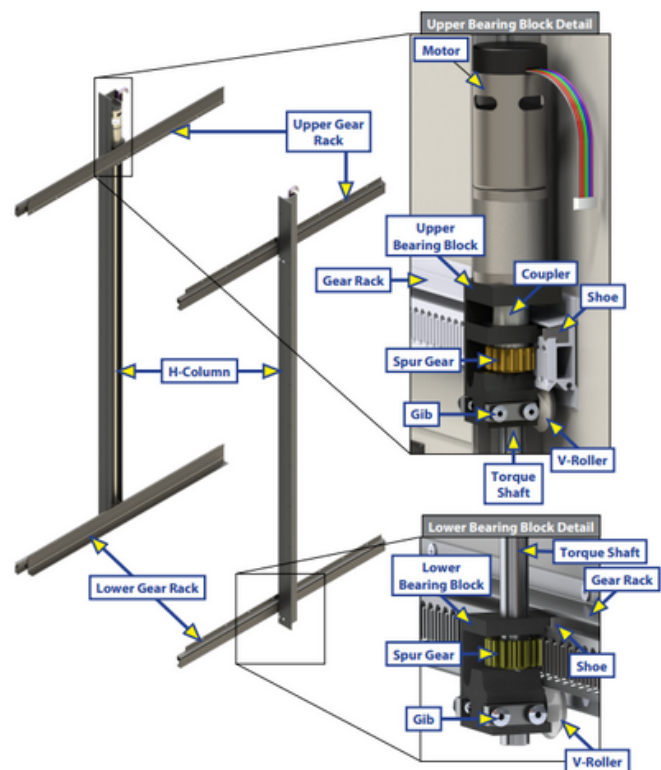

Troubleshooting

Checking Circuit Breakers:

The In-Wall® Slide-out requires a minimum of a 30-amp circuit breaker. Check the 12-volt circuit breaker box for blown circuit breakers, and replace any if necessary. Consult the RV manufacturer's documentation for the location of the 12-volt circuit breaker box, and the location of the In-Wall® Slide-out controller's circuit breaker. If the circuit breaker blows immediately upon replacement, there is a problem with the wiring to the In-Wall® Slide-out controller. Have qualified service personnel check and repair

Obstructions:

Check outside the unit for possible obstructions: tree, post, car, etc. Check inside the unit for any obstructions: luggage, furniture, open cabinets, etc. Also, check for smaller objects that may be wedged under the floor or in the sides of unit. Remove obstructions before proceeding.

Debris In the Rack:

Check the sides of the slide room for any dirt or debris. Small dirt clumps or metal shavings can cause the spur gear to bind up and stop the movement of the slide-out. Use compressed air or a dry brush to remove any dirt or debris from the rack before attempting to actuate the system again.

Error Codes:

During operation when an error occurs, the controller will use the LEDs to indicate where the problem exists. For motor-specific faults, the green LED will blink one time for motor 1, and two times for motor 2. The red LED will blink from 2-9 times depending on the error code. When an error code is present, the controller needs to be reset. To reset the controller, press IN on the slide-out switch, then release. Press IN on the slide-out switch again for normal operation.

Checking Fuses:

The IN-WALL® Slide requires a minimum of 30 amp fuse. Check the 12 volt fuse box for blown fuses, and replace any if necessary. Consult the RV manufacturers documentation for the location of the 12 volt fuse box, and the location of the Room Slide Controller's fuse. If the fuse blows immediately upon replacement, there is a problem with the wiring to the IN-WALL® Slide controller. Have qualified service personnel check and repair.

Error Codes

LED Error Code 2:

- Battery drop out: Battery capacity low enough to drop below 6 volts while running

LED Error Code 3:

- Low battery: Voltage below 8 volts at start of cycle

LED Error Code 4:

- High battery: Voltage greater than 18 volts.

LED Error Code 5:

- Excessive motor current: Motor or wiring to motor has shorted out.

LED Error Code 6:

- Motor short circuit: Motor or wiring to motor has shorted out.

LED error Code 8:

- Wire short between controller and motor: Encoder is not providing a signal. Usually a wiring problem.

LED Error Code 9:

- Hall power short to ground: Power to encoder has been shorted to ground. Usually a wiring problem.

Low Voltage

The Lippert In-Wall® Slide-out Controller is capable of operating the room with as little as 8V DC. But at these lower voltages the amperage requirement is greater. Check voltage at the controller for the location of power connections. If the battery is low, it needs to be charged or the unit should be plugged into shore power or the generator can be run, if equipped. It may be possible to "jump" the unit's battery temporarily to extend or retract the room. Consult the unit manufacturer's owner's manual.

- Note: Always connect directly to the battery and never to the controller power connections.



WARNING!

Never "jump" or charge the battery from the power connections on the IN-WALL® Controller. Always do this at the battery. Failure to do so could result in serious injury.

Electronic Manual Override

- Press the mode button on the controller six times and hold on the seventh for five seconds to enter electronic manual override mode.
- Use the slide-out switch to move both motors in or out.
 - Note: Over-current and short circuit detection are still enabled. Electronic manual override provides 12V DC directly to both motors.
- To exit the electronic manual override mode, press and hold the mode button until the LEDs begin to blink simultaneously. Exiting the override mode resets the motor positions. Motors will have to be resynchronized.
 - Note: During the manual override procedure the motors are not synchronized. Visually watch the room. If one side is moving significantly slower than the other (or not at all) then immediately stop and follow the Motor Disengagement Procedure.

Override Buttons

Please refer to your travel trailer's specific Slide Controller for the "Controller Version #" to obtain the most accurate and up-to-date information on Lippert's website. The diagram below is a general Schwinteck Slide-Out Slide Controller labeled to show what buttons are used when Manually Overriding the system.

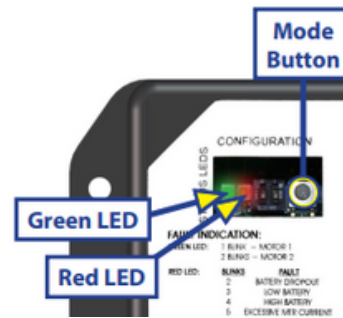

Motor Disengagement Procedure

- Remove motor retention screws located near the top of each vertical column on the outside of the unit. If slide-out is equipped with bulb seal on column, look under bulb seal.
- Locate motor. A. On units built prior to 2011: Bend back wipe seal from outside of unit. B. On units from 2011 to current: See slot in H-column on the inside of the unit.
- Pull motor up until disengaged (roughly 1/2"). A flat-head screwdriver can be used to pry the motor up.
- Reinstall motor retention screw to hold motor in place or remove motor.

For more indepth instructions please contact Lippert or refer to their website.

Motor Disconnection Procedure

Locate the Slide Controller in your unit unplug both motors from the circuit board to release the motor brake. Physically push or pull the slideout into the desired position. Be aware this may require multiple people. It is important the slideout closes as evenly as possible. Once the slide is in the desired position, replug both motors to apply the motor brake for travel.

Norco NXG Slide Mechanism

The NXG SLIDE system provides an unmatched level of durability and precision that was not available in older generations of slide-out mechanisms. Due to the systems rigidity and tightness, a user should experience years of trouble-free performance. All components of the NXG SLIDE mechanism are individually coated with highly effective corrosion-resistant e-coat or plating for extended life of the slide-out drive. Required maintenance is limited to periodic cleaning and lubrication of the main drive arms of the system. The arched design allows the Slide-Out to be stronger, tighter and more durable. The secure connections create a tighter and quieter system.

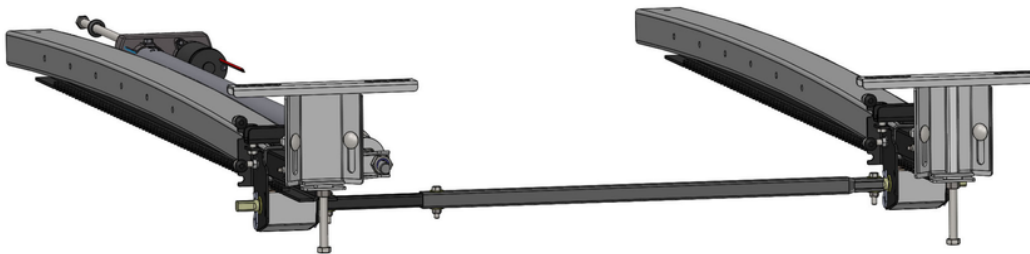

Maintenance

Required maintenance is limited to periodic cleaning and lubrication of the main drive arms of the system. Follow the steps below for recommended lubrication;

- Fully extend the slide-out room.
- Wipe the TOP of the slide-out arms free of any dirt or debris.
- Apply the lube directly to the top of the slide-out arms. We recommend using a wax based, self-cleaning, lubrication, such as DuPont Chain-Saver Wax-Based Chain lube.
- Cycle the room one complete time while spraying the lubrication on/into the top nylon wear block as needed.
- Complete step the fourth (4th) step as needed until the slide-out is operating smooth and quietly. In certain circumstances 24-hour dry time may be required to eliminate excessive noise and/or vibration.

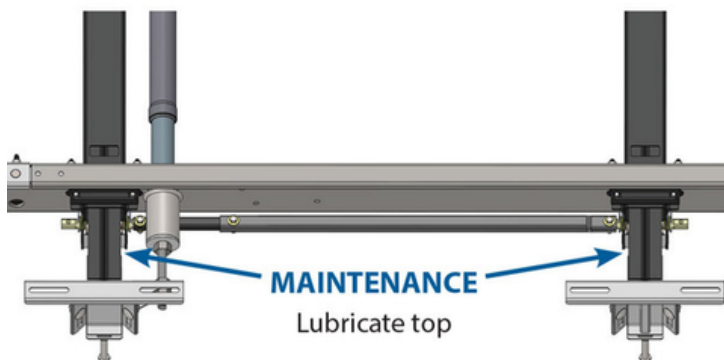

Recommended Lubricant



Adjusting to the Extended Position

- Using the switch, extend the slide-out room to the desired position. Be careful not to overextend the slide-out room.
- Loosen the jam nut (B) on the back of the end condition bracket using a 1 1/8" wrench. Be sure to back this nut off the bracket enough to allow the electric actuator to extend fully and clutch out without moving the actual slide-out room.
- Using the switch, fully extent the actuator. You will hear the actuator motor clutching mechanism when it is fully extended. Some describe it as a "ratcheting" noise.
- Tighten the nylon inserted adjustment nut (A) down to the front of the end condition bracket using a 1 1/16" wrench.
- Tighten the 1 1/8" jam nut (B) back down to the back of the end condition bracket.
- Verify the slide-out is sealed properly in the extended position.

Adjusting to the Retracted Position

- Loosen the 1 1/8" "stop can" (D) jam nut (C) using a 1 1/8" wrench.
- Adjust the stop can jam nut (C) and the stop can (D) away from the main frame rail, allowing enough clearance for the actuator to pull the slide-out room into the desired retracted position.
- Using the switch, retract the slide-out room to the desired sealed position.
- When the room is fully retracted and properly sealed adjust the stop can (D) so it is tight against the main frame rail.
- Tighten down the 1 1/8" jam nut (C) against the stop can to lock the stop can in place.
- Verify the slide-out is sealed properly in the retracted position.

Adjustment Diagram's

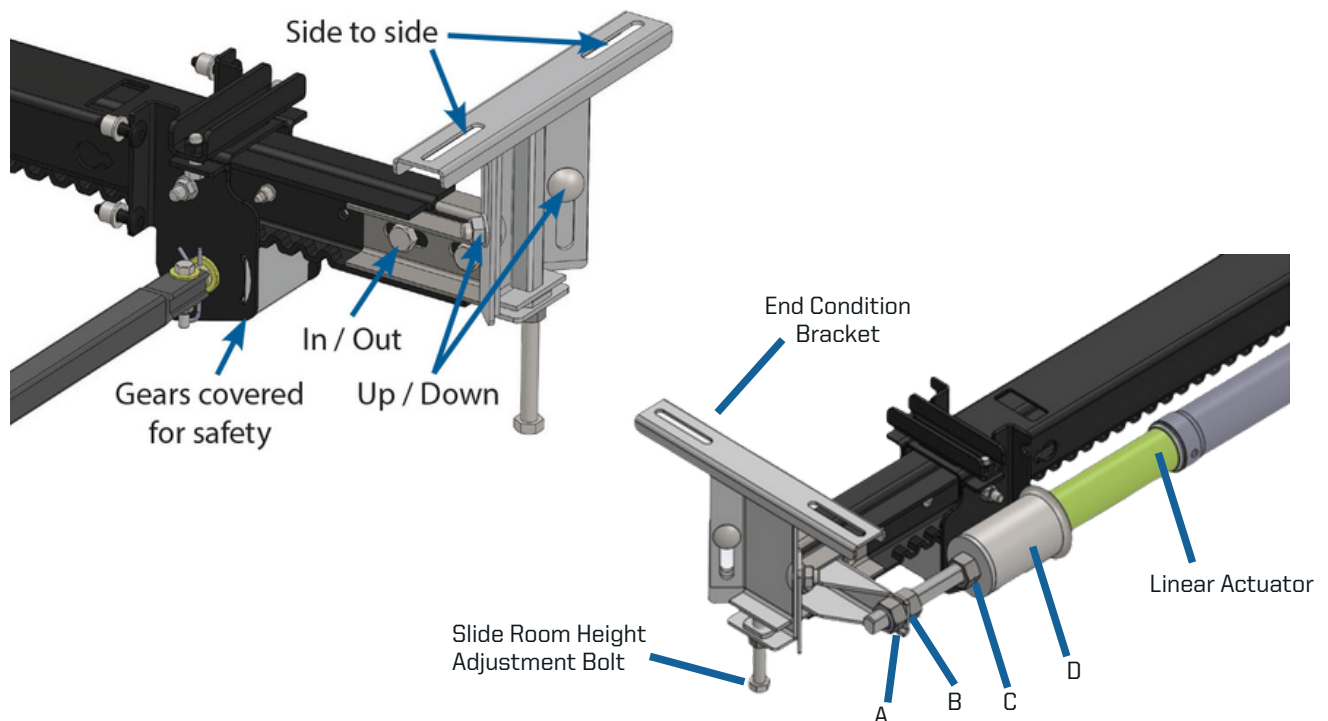

Actuator Motor Identification

In light of Norco's efforts to secure a reliable parts supply for the NXG Slide, they have multi sourced the linear actuators for the "through-frame" slide-outs. Although the two linear actuator assemblies are completely interchangeable, the specific motors of the assemblies are not. If a replacement motor is needed, rather than replacing an entire actuator assembly the actuator motor ONLY can be identified using this guide. Please match the original motor to one of the three motors below to assure a proper replacement will be ordered. You may also provide the BAL Chassis S/N to a member of their technical support team, and they will assist you in locating the correct motor part number

40" Actuator motor,
9,500 RPM, Black,
P/N: 20900114



24" Actuator motor,
5,800 RPM, Black,
P/N: 20900114



40" Actuator motor,
9,000 RPM, Grey,
P/N: 21700061



Interior Care

Important

It is important to perform regular maintenance on your RV. When performing this maintenance, refer to the manufacturer's owner's manual or reach out to an authorized Winnebago dealer for recommended cleaning agents and procedures.

Interior Wood Paneling

All paneling is prefinished plywood, laminated with a film. It may be cleaned with a furniture polish or mild cleaning solution using a soft cloth. Dust regularly. Clean up any spills or liquid immediately to prevent any damage.



CAUTION!

Avoid use of solvent-based cleaners containing kerosene, naphtha, carbon tetrachloride, butane, or abrasives. Unprotected surfaces will be harmed.

Fabrics, Carpets, & Upholstery

All fabrics have been carefully selected to provide a pleasing, and stylish interior. Most dirt can be easily removed with a damp cloth. If badly soiled, use a good quality upholstery cleaner. For drapery we recommend they be vacuumed frequently and a damp cloth can be used to clean stains with detergent and warm water.

Countertops

Never place hot pans or dishes directly on the countertop. Use a hot pad to avoid damage. Never cut food directly on the countertop. Clean with a damp, soapy cloth and dry immediately.

Glass

For decorative glass, mirrors, and windows dust often and use a gentle glass cleaner to remove spots when necessary.

Floor

Vinyl Floor: To prevent damage to the floor, sweep or vacuum regularly to remove dirt and debris. Mop occasionally, avoid allowing water to soak into the flooring.

Carpet: Vacuum regularly to remove dirt and debris. Avoid water or liquid on the carpet, use a rag to dry if this occurs.

Marine grade flooring: Vacuum occasionally to remove dirt and debris. This flooring is designed to handle water. Avoid water on the edges, this could damage the vinyl.

Furniture

All fabric furniture can be vacuumed regular to remove dirt and debris, use a soft brush head to avoid damage. If any furniture is stained, seek professional cleaning services to remove the stain. Before any travel check that furniture is strapped down if needed.

Shower

Winnebago travel trailer shower pan's and surrounding are made from ABS plastic. When cleaning any ABS plastic, be sure to use gentle, non-abrasive products. Soap and warm water with a soft cloth will work! Abrasive products and tools can ruin the shower.

Stainless Steel

Any stainless steel appliances can be cleaned with stainless steel cleaners or glass cleaners. Be sure to avoid using abrasive cleaning clothes. Hard water may cause water spots. Dry to avoid water spots.

Exterior Care

Important

Most exterior parts are made of ABS, fiberglass, aluminum, and rubber materials. The finish on these parts is durable, but not indestructible. Any material and finish will deteriorate in time. Exposure to sunlight, moisture and airborne pollutants can chemically alter the composition of the base and finish materials and cause dulling and fading of the finish. Generally, changes in the finish due to weathering are cosmetic - they are on the surface of the part and do not affect its strength. Weathering can take several forms:

- Chalking: The surface finish has broken down into a fine powder. It usually will wash off.
- Fading: The color of the finish has changed. This can be caused by chemicals spilled on the surface, staining it, or by changes in the pigments used in the finish.
- Yellowing: Usually caused by chemical changes in the material and pigments.

The best insurance against these effects is routine maintenance. If the finish is not washed thoroughly and waxed, the surface can deteriorate very rapidly. The following maintenance guidelines can help you reduce these effects:

- Wash the exterior of the trailer at least monthly. Wash with a mild soap. Avoid using strong alkaline cleaners and abrasives.
- Wax the exterior at least once or preferably twice a year. Aluminum surfaces can be waxed with a good automotive wax.
 - When waxing, always read and follow the instructions and precautions on the container.
 - Some cleaners and waxes are recommended for use on only certain types of surfaces.
- Occasionally, one part may weather more rapidly than a similar part. In those cases, a light rubbing compound may be required. Always follow with a high quality wax.



IMPORTANT!

Never take your travel trailer through an automatic car wash.

TPO Roof

TPO (Thermoplastic Polyolefin) is a rubber roofing material primarily made from recycled rubber which is installed on all Winnebago travel trailers. Periodic cleaning is the primary maintenance required for rubber roof surfaces. Most Winnebago travel trailer roofs are fully walkable, however, check with an authorized dealer or service tech to be sure. The recommended maintenance includes:

- Inspect the roof every 3 months for damage, breaks in caulks or sealant and seals around fasteners and accessories
 - If any cracks are found, remove loose sealant and caulk by hand if possible. If not, leave the sealant until you can remove it by hand.
- Contact an authorized Winnebago dealer for any repairs to the seals or caulks.
- Clean the roof after inspecting and completing any repairs to ensure water does not enter the roof membrane at those areas.

To clean a TPO roof:

- Rinse the surface with a pressure washer of 2,000 PSI or under, or a household hose.
- Clean the roof in sections with a soft bristle brush or broom and a TPO-safe, non-abrasive roof cleaning solution. Push the dirt you washed off toward the drain.
- If there are stubborn stains, these can be removed with a kitchen cleaner containing bleach.
- Rinse the cleaning solution completely off with the pressure washer or household hose.
- Inspect the roof again to make sure there are no leaks or cracks.

Windows & Doors

All windows and doors are susceptible to leaks. Especially during extreme weather or rain. It is important to inspect each of these often and contact an authorized Winnebago dealer if water is leaking inside.

- Keep moving parts of windows and latches adjusted and maintained.
- Lubricate the windows with a light oil or powdered graphite at least once a year.
- Check and tighten the screws holding the windows in place periodically.
- Check the weather sealant.
- Clean screens by gently wiping with a damp cloth or soft flat brush.
- Inspect the seals around doors and windows every three months.
- Clean windows with a glass cleaner or when you wash the outside of your unit.

Resealing Windows & Doors

If upon inspection, every 3 months, the following defects are evident, the affected area must be resealed:

- Excessive amount of sealant protruding from joints
- Sealant cracked or peeling
- Voids in sealant

Consult an authorized Winnebago dealer for type of sealant.

NOTE: Do not seal the bottom flanges of windows and doors. Two sealant voids have been intentionally left in the bottom flange sealant to provide exterior drainage in case of leakage.

If you find the above defects:

- Use a plastic scraper to remove excess sealant.
- Clean all areas to be resealed with mineral spirits and clean rags.
- Make sure all areas to be resealed are dry before new sealant is applied.



WARNING!

Mineral spirits is a flammable liquid. Use extreme care when handling. Do not expose to open flame, sparks or smoking materials. Do not use in unventilated areas.

Vents

All exterior sidewall vents need to be kept clear of any obstructions for the appliances to properly vent. Before travel, inspect each vent checking for any obstructions including, birds nest, leaves, webs, or debris. Using a rag clear off any obstructions found.

Locks

- Lubricate locksets, latches and hinges in entry doors and exterior storage compartments at least annually with powdered graphite.
- If the trailer is located at a beach or is exposed to salt air, frequent lubrication may be required.
- Record and safely store the identification number of the keys. The lock manufacturer will need this information for duplicate keys in case of loss.



IMPORTANT!

Record the identification number of the keys below:

Sealant

It is important to check the sealants every 3 months to ensure there is no damage due to exposure to the elements, debris, cold temperatures, etc., on your trailer. If upon inspection there are cracks, peeling, voids, breaks, or gaps in the sealant, immediately contact an authorized Winnebago dealer to obtain the correct sealant and/ or obtain service to reseal. If there is a leak, immediately contact an authorize Winnebago dealer to check the sealants around the area. It is important to reseal at least once a year as preventative maintenance.

Rear Bumper

All Winnebago travel trailers are equipped with a 2-inch accessory receiver hitch. Depending on the floorplan and model of your unit, the weight limit may vary. It is important to weigh your travel trailer after attaching any accessories to ensure the GVWR and hitch weight do not exceed their limits.

The Winnebago accessory receiver hitches are Thule and Yakima accessible, this allows you to plug and play with their accessories.

Roof Ladder

Most Winnebago travel trailers are equipped with a roof ladder. This ladder may be located on the rear or side of the unit. Read the weight limit sticker on the ladder itself before using. Practice safety when climbing the ladder or walking on the roof. Ensure your travel trailer is equipped with a fully walkable roof.



CAUTION!

Ladder capacity is 300lb. (136 kg.) maximum.

- Exceeding the maximum capacity could lead to ladder collapse and possible personal injury.
- Always face ladder and use both hands to climb slowly. Failure to comply can result in a fall hazard and result in personal injury.

**DO NOT EXCEED
300 LBS
EVENLY DISTRIBUTED**

Exoskeleton

Winnebago HIKE travel trailers have a patented Exoskeleton. This Exoskeleton is Thule and Yakima compatible. Practice caution when loading gear onto and off of the rack. Do not exceed the weight limit of the ladder, roof, or cross beams. Check with gear and accessory holders manufacturers for care, warranty, and use.

Underbelly

All Winnebago travel trailers have a fully enclosed underbelly. This is to prevent unnecessary wear and tear on the underside of your travel trailer. Check the underbelly for tears or openings when checking the roof and seals of your unit. Contact an authorized Winnebago dealer for any maintenance to the underbelly or maintenance that requires the removal of this piece.

Winterizing Exterior

After completing the plumbing system winterization process, follow the steps below to care for the exterior of your trailer before storage.

- Inspect the roof, underbelly, and sidewalls for damage or leaks that may cause damage while in storage.
- Check that all windows, doors, and vents are securely closed.
- Turn off all electricity to the refrigerator and cleanout any food or drinks. Be sure to defrost to avoid leaking in the unit.
- Shut off propane cylinder valves.
- Cover all exterior openings to prevent rodents from nesting or causing damage.
- Cover the A/C.
- Disconnect 120-volt SC power.
- Do not use the power stabilization jacks while in storage.
- Remove auxiliary batteries.

When storing your RV, find a covered area to prevent damage. If storing your RV inside is not an option, purchase an RV cover. When storing your RV outside with a cover, you will need to clear any snow that falls on top to prevent structural damage.

Maintenance & Storage

Important

This is to serve as a suggested list of maintenance items to perform on your trailer. For a full list of maintenance items, please refer to each component's owner's manual supplied with your trailer. Check in with your dealer at the time of purchase for any additional maintenance recommendations.

At Delivery

After purchasing your new Winnebago travel trailer, the dealer should go through a Retail Post Delivery Inspection with you. This is important to complete to avoid having any warranty issues right away. If the unit is on the dealer's lot for an extended period of time, there may be maintenance fixes that need to be completed before you finish purchasing the unit.

After Delivery, Before Travel

Once your unit is ready to take home from the dealership, there are tasks that need to be performed before your maiden voyage. Those include;

- Inspect the roof, sidewalls, and underbelly
- Check propane system for leaks
- Check wheel lug nuts are torqued to the correct specifications
- Sanitize the Fresh Water system before using
- Test safety alarms, change batteries as needed
- Weigh travel trailer, unloaded to double check your GVWR
- Weigh travel trailer loaded, to ensure you are not exceeding weight limits

After 200 Miles of Adventures

After you travel 200 miles, whether on your first trip or after a few,

- Check wheel lug nuts are torqued to the correct specifications
- Have an authorized Winnebago Dealer check and adjust the brakes

Before Each Trip

Once you have completed your initial maintenance and maiden voyage, it is important to perform routine maintenance on your trailer before each trip:

- Inspect the roof, sidewalls and underbelly
 - Re-seal if needed
 - Contact an authorized Winnebago dealer for more in-depth maintenance
- Check the auxiliary battery
 - Never travel with an uncharged battery
- Check all lights on both the tow vehicle and travel trailer
- Check the tire pressure on all tires including the spare
- Check wheel lug nuts are torqued to the correct specifications
- Check the brakes
- Test alarms
- Weigh trailer















Required Maintenance Schedule

Service To Be Performed	Every Trip	Every Month	Every 3 Months	Every 6 Months	Annually	After Winterization
Check all safety detectors, Replace batteries as need	✓			✓		✓
Check fire extinguisher				✓	✓	
Torque Lug Nuts	✓		✓			✓
Inspect tires for tread wear, tire pressure, debris	✓		✓			✓
Balance Tires (After 1st 1,000 miles & as needed after)					✓	
Pack wheel bearings					✓	
Inspect Brakes					✓	
Inspect Brake Wiring	✓				✓	
Inspect Hitch Components	✓					
Lubricate Locks					✓	
Lubricate Coupler Latch & Socket		✓				
Inspect Suspension					✓	

Required Maintenance Schedule

Service To Be Performed	Every Trip	Every Month	Every 3 Months	Every 6 Months	Annually	After Winterization
Clean & Sanitize appliances						
Clean appliance vents						
Inspect awning for damage, clear any debris or objects						
Complete LPG System Check and pressure check						
Visually Inspect Exposed LPG System Components						
Have LPG System Checked for Leaks by an Authorized dealer						
Clean Battery Cables and Terminals, Check Fluid Levels						
Check Outlets						
Check Water System Components						
Drain holding tanks after every trip						
Winterize before storage						

Required Maintenance Schedule

Service To Be Performed	Every Trip	Every Month	Every 3 Months	Every 6 Months	Annually	After Winterization
Check Slide Out for any debris or obstructions						
Have an authorized dealer inspect and adjust Slide Out						
Check all top sealed seams (baggage doors, slide out windows, patio lights, vents, awning rails, etc.) and reseal						
Clean roof						
Open and close Emergency Egress Windows						
Check entry door and baggage door latches & locks						
Lube hinges and spray locks with dry graphite						
Clean and wax the exterior sidewalls						
Check Underbelly for any tears, loose wires, or debris						

General Cleaning Instructions

Item	Maintenance
Countertops	Clean with damp, soapy cloth and dry immediately.
Refrigerator	Clean and remove food after each trip.
Stove and Sinks	Clean with appropriate cleaners.
Cushions	Use foam type cleaners, or warm, soapy water.
Vinyl	Use vinyl cleaner or soapy water.
Living Room Drapes	Dry clean only.
Bedroom Curtains	Hand wash with mild detergent and drip dry. DO NOT dry in the dryer.
Bedspread	Dry clean only. DO NOT dry in the dryer.
Carpet	Use recommended carpet cleaner, vacuum.
Vinyl Floor Covering	Wash with soapy water, rinse, and wax.
Prefinished Paneling	Use furniture wax or polish.
Propane Gas System	Check for crimped tubing or other damage. Have an authorized dealer perform a leak test.
Water System	Check all hoses, fittings, and connections for leaks. Clean tank discharge filter and sanitize system when necessary.
Electrical	Examine all wiring and connections.
Fire Extinguisher	Check pressure regularly and note on inspection tag
Side Metal	Clean with soapy water and wax with a nonabrasive wax.
Air Conditioner	Clear evaporator and condenser coils, filter and pan. Cover outside when not in use.

Miscellaneous Information

Effects of Prolonged Occupancy

Winnebago travel trailers are not designed or intended to be used as permanent housing. Using this product for long term or permanent occupancy may lead to premature deterioration of appliances, plumbing, interior finishes, fabrics, carpeting and drapes. Damage or deterioration due to long term occupancy is not considered normal, and constitutes misuse or abuse under the warranty terms, therefore voiding your warranty protection.

Humidity & Condensation

Moisture condensing on the inside of windows is a visible indication that there is too much humidity inside the coach. Excessive moisture can cause water stains or mildew, which can damage interior items such as upholstery and cabinets.

When you recognize the signs of excessive moisture and condensation, you should take immediate action to minimize their effects.

You can help reduce excessive moisture inside the trailer by taking the following steps:

- Ventilate with outside air: Partially open one or more windows and a roof vent to circulate outside air through the trailer. In cold weather, this ventilation may increase use of the furnace, but it will greatly reduce the condensation.
- Minimize moisture released inside the trailer: Run the range hood fan while cooking and open a bath vent while bathing or showering to carry water vapor out of the trailer. Avoid making steam from boiling water excessively or letting hot water run. Avoid bring in extra moisture by way of soaked clothing or snow on shoes. Do not hang-dry wet clothing inside, unless using the HIKE 100 wet bath with gear drying storage.

Mold, Moisture, and Your Trailer

Mold growth should be avoided indoors. To reduce the ability of mold growth keep the environment as clean as possible. Minimize moisture in your trailer and keep humidity low. Do not allow condensation to build up, open windows or vents to minimize. Use of the air conditioner can assist in removing moisture from the air. Avoid leaks, but if leaks do occur, make repairs promptly. Avoid bring mold into your trailer. Plants, cloths, books, and other household items may already have mold present.

If mold is found, clean the area with a concentrate of soap and bleach. Items that contain mold that cannot be easily cleaned should be removed from the vehicle and professionally cleaned.

The effect of mold and airborne mold spores may cause irritation to some people. Experts disagree on the level of exposure that may cause health concerns.

If Winnebago determines that mold is present in the Winnebago trailer as a result of a manufacturing defect reported to Winnebago within the limited warranty period, Winnebago will clean the affected area(s) and/or replace affected items as it deems necessary. This is the extent of coverage provided by Winnebago. Winnebago, however, will not assume responsibility for mold deemed to be a result of a trailer users lack of timely and appropriate action to mitigate circumstances should a problem occur.

If Winnebago determines that mold is present due to conditions it determines is not a result of a manufacturing defect found within the warranty period, Winnebago will not provide any financial assistance to the repair of the condition.

Troubleshooting

Fridge

Problem	Possible Cause	Suggested Remedy
The fridge will not operate.	<ul style="list-style-type: none"> The power supply cord is disconnected. The refrigerator is powered off, A household fuse or circuit breaker has tripped. 	<ul style="list-style-type: none"> Ensure that the refrigerator is connected and power is supplied. Hold the mode button for three seconds to turn on the refrigerator. Ensure that there is power supplied to the refrigerator.
Food in the fridge compartment is freezing	<ul style="list-style-type: none"> The internal temperature is set too cold. 	<ul style="list-style-type: none"> Adjust the temperature to a warmer setting.
The internal temperature in the refrigerator compartment is not cool enough.	<ul style="list-style-type: none"> The air vents in the fresh food compartment are blocked; this prevents the movement of cold air. The refrigerator is placed too close to heat sources, or poor ventilation exists. The door is opened too often or not closed properly. A large amount of food has just been added to the fridge compartment. The temperature setting is adjusted too warm. 	<ul style="list-style-type: none"> Adjust the temperature to a warmer setting. Ensure that the vents are clear and that there are proper clearances around the refrigerator. Limit the amount of time that the door is opened during operation. Cool food before inserting it into the fridge. Adding warm food to the refrigerator delays cooling. Set the thermostat to a cooler setting.
The fridge seems to make unusual noise.	<ul style="list-style-type: none"> The fridge is not leveled on the floor. The body of the refrigerator touches a wall. 	<ul style="list-style-type: none"> Ensure that the refrigerator is properly leveled. Ensure that there are proper clearances around the fridge.
There is interior moisture build-up.	<ul style="list-style-type: none"> The door is opened too often or not closed properly. The room is humid. The food is not packaged correc 	<ul style="list-style-type: none"> Limit the amount of time the door is opened during operation and ensure that the door is properly closed after opening. Install the refrigerator in an area with less humidity, if possible. Follow the recommended packing instructions.
The door will not close completely.	<ul style="list-style-type: none"> Food packages are keeping the door from closing properly. The shelves are out of position. The gaskets are dirty. The refrigerator in not le 	<ul style="list-style-type: none"> Ensure that contents in the cooling compartment do not obstruct the door. Ensure that the shelves are in their correct positions. Clean the gaskets with a damp cloth. Ensure that the fridge is properly leveled.

Carbon Monoxide & Propane Alarm

STATE	GREEN LED	RED LED	AUDIBLE HORN
Normal Operation	ON	OFF	OFF
Power OFF	OFF	OFF	OFF
Self Test	OFF	ON/ Flashing	4 Chirps/ Constant beeps
CO Alarm	OFF	Flashing	4 Chirps
Propane Alarm	OFF	ON	Constant Beeps
Alarm Silenced (5 min. max)	OFF	Flash each second	OFF
Low Battery	Flash each minute	Flash each minute	Chirp each minute
End-of-Life or Other Failure	OFF	Double flash each minute	Chirp each minute

RESULT	ALARM OUTPUT	ACTION
CO or Propane Failure or End-of-Life	Long beep with red LED blinking	Replace alarm
Low Battery	Long beep with red and green LED on solid	Charge or replace RV battery

Microwave

Problem	Possible Cause	Suggested Remedy
The oven will not start	<ul style="list-style-type: none"> Electrical cord is not plugged in. Door is open. Wrong operation is set. 	<ul style="list-style-type: none"> Plug into the outlet. Close the door and try again. Check instructions.
Arcing or Sparking	<ul style="list-style-type: none"> Materials to be avoided in microwave oven were used. The oven is operated when empty. Spilled food remains in the cavity. 	<ul style="list-style-type: none"> Use microwave-safe cookware only. Do not operate with oven empty. Clean cavity with wet towel.

Water Heater

Problem	Possible Cause	Suggested Remedy
Water heater will not fire up	<ul style="list-style-type: none"> • Obstructions in the burner tube and exhaust • Blown fuse • Bad circuit board 	<ul style="list-style-type: none"> • Clear obstructions • Check 12- Volt power • Contact authorized dealer
Odor	<ul style="list-style-type: none"> • A rotten egg odor (hydrogen sulfide) may be produced when the electro galvanic action of the cladding material releases hydrogen from the water. If sulfur is present in the water supply the two will combine and produce an unpleasant smell. 	<ul style="list-style-type: none"> • Turn off main water supply. Drain the water heater tank and reinstall drain plug. Remove the pressure-temperature relief valve. Mix solution of 4 parts white vinegar to two parts water. With a funnel, carefully pour solution into tank. • Cycle water heater with the above solution, letting it run under normal operation 4-5 times. • Remove the drain plug and thoroughly drain all water from the tank. Flush the water heater to remove any sediment. You may flush the tank with air pressure or fresh water. pressure may be applied through either the inlet or outlet valves on the rear of the tank or through the pressure temperature relief valve coupling located on the front of the unit. TO FLUSH TANK WITH AIR PRESSURE: Insert your air pressure through the pressure-temperature relief valve coupling. With the drain valve open, the air pressure will force the remaining water out of the unit. To flush tank with water pressure: Fresh water should be pumped into the tank with either the onboard pump or external water pressure. Continue this flushing process for approximately 5 minutes, allowing the fresh water to agitate the stagnant water on the bottom of the tank and forcing the deposits through the drain opening. • Replace drain plug and pressure-temperature relief valve. • Refill tank with fresh water that contains no Sulphur.

Circuit Board

Problem	Possible Cause	Suggested Remedy
Blown Fuse Indicators	<ul style="list-style-type: none"> • Blown fuse • Blown fuse after rep 	<ul style="list-style-type: none"> • Replace the fuse with a known good fuse of the same rating. • If the replacement fuse blows again, check that circuit for a short or overload condition.

Furnace

Problem	Solution
Furnace will not light- Blower does not turn on.	<ul style="list-style-type: none"> • Check the main fuse panel for a blown fuse. • The furnace-installed breaker switch may be tripped or OFF- Contact a trained RV service provider. • The 12 Volt DC power is low; check the RV system voltage. • The furnace may be in lockout. Reset the furnace by switching the thermostat to OFF for 10 seconds, then switch the thermostat to ON. If air is in the propane line, repeat this process up to three times.
Furnace will not light- Blower does turn on.	<ul style="list-style-type: none"> • Air is in the LP line. Purge the air by turning on other appliances (like a cooktop) that are further downstream from the LP tanks. • The thermostat is not set to heat or a high enough temperature. Adjust the thermostat.
Furnace shuts off before it reaches the desired temperature.	<ul style="list-style-type: none"> • Check to make sure all vents are open and not covered. • Check the air intake to make sure it is not blocked or obstructed.

Black Water Tank

Problem	Solution
Tank will not drain	<ul style="list-style-type: none"> • Buildup in tank, check for buildup. Use plenty of water when flushing the system. Use a minimum amount of toilet paper.

Schwintek Slide-Out

For troubleshooting information, refer to page 70.

Supplier Contact Information

Brand	Website	Phone Number
Azdel Onboard	azdelonboard.com	onboard@azdel.com
BAL by Norco	balrvproducts.com	(877) 557-7788
Coach-Net	coach-net.com/winntow	(877) 801-0333
Crane Composites	cranecomposites.com	1 (815) 467-8600 or 1 (800) 435-0080
Dexter	dexteraxle.com	(574) 413-9066
Dometic	dometic.co	(800) 544-4881
Furrion	furrion.com	(888) 354-5792
GasFlo Products	gasflo.com	(973) 276-9011
Goodyear	lionsheadtireandwheel.com	(574) 533-6169
GoPower!	gopowersolar.com	1 (866) 247-6527
High Pointe	collins-n-co.com	(574) 848-1118
Lippert	lci1.com	(800) 772-7262
RiverPark Inc.	riverparkinc.com	(800) 442-7717
RVSafe Alarm	rvsafealarm.com	(714) 934-8512
WFCO	wfcoelectronics.com	(877) 294-8997
Winegard Company	winegard.com	(800) 288-8094

Index

Pre-Retail Delivery Inspection.....	8
Owner's Contact Information.....	9
Customer Service Contact Information.....	11
Comfort Tech & Explorer Tech Packages.....	13
NHTSA Contact Information.....	17
Transport Canada Contact Information.....	18
Gross Vehicle Weight Rating.....	19
Unloaded Vehicle Weight Rating.....	19
Cargo Carrying Capacity.....	19
Gross Axle Weight Rating.....	19
Load Limits.....	20
Federal Certification Label.....	20
Tire & Loading Information Label.....	20
Cargo Carrying Capacity Label.....	20
To Determine Gross Axle Weight Rating- Both Axles.....	21
To Determine Gross Axle Weight Rating- Each Axle.....	21
To Determine Hitch Weight.....	21
Tire Fundamentals.....	23
Spare Tire & Cover.....	23
Tire Size.....	23
Tire Pressure & Load Limits.....	23
Tire Size Code.....	24
Tire Date Code.....	25
Speed Rating.....	26
Load Range & Ply Rating.....	26
Load Index & Load Carrying Capacity.....	26
Size Specific Specifications.....	26
Tire Pressure & Load Limits.....	27
Checking Tire Pressure.....	27
Maintaining Proper Tire Pressure.....	27
Tire Tread.....	28
Tire Wear Measurement Test.....	28
Tire Tread Wear Indicator.....	28
When to Replace Tires.....	28
Tips for Replacement.....	28
Tire Repair.....	29
Tire Blowout.....	29
Changing Tires.....	29
Tire Balance and Wheel Alignment.....	29
Tips on Wheel Torqueing.....	30
Wheel Nut Torque Information.....	30
Dexter Axles.....	31
Reading An Axle Label.....	31
Double Eye Leaf Spring Maintenance.....	31
TORFLEX Maintenance.....	31

Index

BAL Independent Suspension.....	32
Tow Vehicle Specifications.....	33
Adhere to Traffic Laws.....	33
Tow Vehicle Tune-up.....	33
Battery and Alternator.....	33
Rearview Side-Mounted Mirrors.....	33
Electronic Brake Controllers.....	33
Power Tongue Jack.....	34
Safety Chains.....	34
Weight Distribution.....	34
Rear Bumper Limitations.....	34
Breakaway Device.....	34
Hitch Connection.....	35
Hitches.....	35
Hitch Height.....	35
Weight Distribution Hitch.....	35
Sway Control.....	35
Secure for Travel.....	36
Vehicle & Trailer Hookup.....	36
Tow Vehicle Battery.....	38
Brake Controller.....	38
Battery Isolator.....	38
Braking Tips.....	38
Breakaway Switch.....	39
Breakaway Switch Care.....	39
Breakaway Switch Test.....	39
Trailer Brakes.....	40
Grounding.....	40
Brake Inspection & Adjustment.....	40
Parking & Leveling Tips.....	41
Parking & Leveling Procedures.....	41
Side-to-Side Leveling.....	41
Front-to-Rear Leveling.....	41
Stabilizing Jacks.....	41
Self-Contained vs. Utility Hookup.....	42
Microwave.....	43
Microwave Convection Oven.....	43
Oven.....	43
Range Hood.....	43
Range Top with Oven.....	44
Refrigerator.....	44
Powered Patio Awning.....	45
Manual Batwing Awning.....	45
Portable Induction Cooktop.....	45
Outdoor Kitchen.....	45

Index

CO Detector.....	47
Common Sources of CO.....	47
Indications of Poisoning.....	47
CO Maintenance.....	47
Furnace.....	48
Thermostat- Wall Mounted.....	48
Roof Vents.....	48
Air Conditioner.....	48
Truma Aventa A/C.....	48
Fireplace.....	48
Propane.....	49
Propane Precautions.....	49
If You Smell Propane.....	50
Propane Tanks.....	50
Safety Regulations.....	50-51
Propane Gas Regulator.....	51
QCC1 Coupler.....	51
Lighting Propane Appliances.....	51
Filling Propane Cylinder.....	51
Propane Leak Test.....	52
Installing Propane Tanks.....	52
After Every Tank Removal.....	52
12-Volt Chassis Electrical.....	53
12-Volt Fuse Block Panel.....	53
12-Volt Circuit Breaker & Reset.....	53
110-Volt AC System.....	54
The Power Converter.....	54
Battery Disconnect Switch.....	54
Ground Fault Interrupter.....	55
GFI Testing.....	55
200-Watt GO Power! Overlander Solar Kit.....	56
Side Mount Solar Prep.....	57
Tire Pressure Monitoring System Prep.....	57
Voyager Backup Camera Prep.....	57
All-in-One Control Panel.....	57
12-Volt Tank Pad Heaters.....	57
USB/USBC Charge Ports.....	58
WiFi Prep.....	58
Xantrex Freedom X 3,000 Watt Inverter.....	58
Lithionics 320-Amp-hour Lithium-Ion Battery.....	59
Fresh Water System.....	60
Filling with A Gravity Fill	60
Filling without A Gravity Fill.....	60
City Water.....	60

Index

Fresh Water System Sanitizing.....	61
Drain the Fresh Water System.....	61
Holding Tanks & Draining System.....	62
Black Water Holding Tank.....	62
Gray Water Holding Tank.....	62
Emptying Black & Grey Tanks.....	62
Cassette Toilet.....	63
Showermiser Water Reclamation.....	63
Truma AquaGo Water Heater.....	63
Water Heater.....	63
Water Heater Bypass.....	63
When to Winterize.....	64
Supplies Needed to Winterize.....	64
Drain the Fresh Water System.....	64
Winterizing with Antifreeze.....	65
TV Antenna.....	66
TV Booster.....	66
Satellite.....	66
TV.....	66
Entertainment Center & Speakers.....	66
Blinds & Pleated Shades.....	67
Draperies & Bedspreads.....	67
Fabrics & Upholstery.....	67
Carpeting.....	67
Fabric Color Fading.....	67
Dream Dinette.....	68
U-Shaped Dinette.....	68
Slide-Out Room.....	69
Opening the Slide-Out.....	69
Closing the Slide-Out.....	69
Slide-Out Maintenance.....	69
Manually Operating Slide-Out.....	69
Prior to Operation of Schwintek In-Wall Slide-Out.....	70
Extending Slide-Out Room.....	70
Retracting Slide-Out Room.....	70
Slide-Out Assembly Diagram.....	70
Troubleshooting.....	71
Error Codes.....	71
Low Voltage.....	72
Electronic Manual Override.....	72
Override Buttons.....	72
Motor Disengagement Procedure.....	72
Motor Disconnection Procedure.....	72
Norco NXG Slide Maintenance.....	73

Index

Adjusting to the Extended Position.....	74
Adjusting to the Retracted Position.....	74
Adjustment Diagram.....	74
Actuator Motor Identification.....	75
Interior Wood Paneling Care.....	76
Fabrics, Carpets, & Upholstery Care.....	76
Countertops Care.....	76
Glass Care.....	76
Floor Care.....	76
Furniture Care.....	76
Shower Care.....	76
Stainless Steel Care.....	76
Important Exterior Care Information.....	77
TPO Roof Care.....	77
Windows & Doors Care.....	78
Vent Care.....	78
Lock Care.....	78
Sealant Care.....	78
Rear Bumper Care.....	78
Roof Ladder Care.....	79
Exoskeleton Care.....	79
Underbelly Care.....	79
Winterizing Exterior.....	79
Important Maintenance & Storage Information.....	80
Maintenance At Delivery.....	80
Maintenance After Delivery, Before Travel.....	80
Maintenance After 200 Miles of Adventures.....	80
Maintenance Before Each Trip.....	80
Required Maintenance Schedule.....	81-83
General Cleaning Instructions.....	84
Effects of Prolonged Occupancy.....	85
Humidity & Condensation.....	85
Mold, Moisture, and Your Trailer.....	85
Troubleshooting Fridge.....	86
Troubleshooting Carbon Monoxide & Propane Alarm.....	87
Troubleshooting Microwave.....	87
Troubleshooting Water Heater.....	88
Troubleshooting Circuit Board.....	88
Troubleshooting Furnace.....	89
Troubleshooting Black Water Tank.....	89
Troubleshooting Schwintek Slide-Out.....	89

MAINTENANCE NOTES

DATE -

DEALERSHIP -

REQUESTED REPAIR -

NOTES -

DATE -

DEALERSHIP -

REQUESTED REPAIR -

NOTES -

MAINTENANCE NOTES

DATE -

DEALERSHIP -

REQUESTED REPAIR -

NOTES -

DATE -

DEALERSHIP -

REQUESTED REPAIR -

NOTES -

MAINTENANCE NOTES

DATE -

DEALERSHIP -

REQUESTED REPAIR -

NOTES -

DATE -

DEALERSHIP -

REQUESTED REPAIR -

NOTES -

MAINTENANCE NOTES

DATE -

DEALERSHIP -

REQUESTED REPAIR -

NOTES -

DATE -

DEALERSHIP -

REQUESTED REPAIR -

NOTES -

MAINTENANCE NOTES

DATE -

DEALERSHIP -

REQUESTED REPAIR -

NOTES -

DATE -

DEALERSHIP -

REQUESTED REPAIR -

NOTES -

3-Year Limited Structural Warranty

The Winnebago Towables Limited Structural Warranty covers your RV for a period of three (3) years from the date of purchase by the original owner. This structural warranty covers the workmanship attributable to Winnebago's manufacturing and assembly of the structural portions of your RV.

Structural coverage includes:

- Main steel frame
- Steel frame outriggers & cross members
- Skeletal framing (wall studs, floor joists, roof rafters)
- Sidewall assembly
- Flooring assembly
- Roof assembly
- Roof materials installation
- All slide out boxes & applicable structural assembly
- Fiberglass front caps (paint fade cracking)

1-Year Limited Base Warranty

In addition to the 3-Year Limited Structural Warranty, The Winnebago Towables Limited Warranty covers this recreational vehicle (RV) for a period of one (1) year from the date of purchase of the RV by the first retail purchaser, once purchased from an independently owned and authorized Winnebago Towables dealer. This Limited Warranty is transferrable to a second owner, for the remainder of the original 12 months of coverage. This Limited Warranty does not cover those items identified in the "Exclusions from Coverage" section of this Limited Warranty

Lifetime

Exterior LED Lights

12 Years

Diflex TPO Roof Membrane

Flex PEX Piping

11 Years

Dexter Torsion Axles

6 Years

Spring Type Axles

Tires- Manufacturer's Warranty

Shaw Flooring

3 Years

Exterior Graphics

2 Years

Arterra - Converter

Dometic- Water Heater

Dometic- Air Conditioner

Dometic- Toilet

Dometic- Furnace

Dometic- Gas/ Electric Refrigerator

Dometic- Stove/ Oven

King Jack- Antenna

Suburban- Cooking Appliances

Shurflo- Water Pump

Crane Composites- Exterior Fiberglass

Norcold- Refrigerator

1 Year

Dometic- 12-Volt Refrigerator

THIS IS ONLY A SUMMARY. FOR COMPLETE INFORMATION REGARDING THE ACTUAL WARRANTY STATEMENT(S) CONSULT THE WRITTEN WARRANTY PROVIDED BY EACH SUPPLIER WHICH CAN BE FOUND IN THE COMPONENT SUPPLIER OWNER'S MANUAL INCLUDED WITH YOUR RECREATIONAL VEHICLE OR ON THE SUPPLIER(S) WEBSITE.

Winnebago Limited Towable Warranty

Thank you for purchasing a Winnebago travel trailer. This document explains certain rights and limitations provided under the terms of this Limited Warranty. Please review this document carefully. This One-Year Limited Towable Warranty applies to Winnebago Towable products.

One-Year Limited Warranty

The Winnebago Towables Limited Warranty covers this recreational vehicle (RV) for a period of one (1) year from the date of purchase of the RV by the first retail purchaser, once purchased from an independently owned and authorized Winnebago Towables dealer. This Limited Warranty is transferrable to a second owner, for the remainder of the original 12 months of coverage. This Limited Warranty does not cover those items identified in the "Exclusions from Coverage" section of this Limited Warranty. This Limited Warranty covers the RV against Substantial Defects in material and workmanship attributable to Winnebago's manufacture and assembly of the RV. Substantial Defects are those defects which prevent the RV from performing its intended use for short term recreational camping.

Additionally: Minor adjustments including but not limited to, adjustments to drawers, interior doors, latches, awnings, and window treatments will be covered at no cost to you for the first ninety (90) days of the Limited Warranty Period (see "Exclusions from Coverage" section of this Limited Warranty).

There is no warranty, of any nature, beyond what is contained in this Limited Warranty. No person has authority to enlarge, amend, or modify this Limited Warranty. Repairs will not extend the warranty coverage or period in which you may enforce an action, unless prohibited by law. This RV has been sold to an independent authorized dealer of Winnebago Towables. The dealer is NOT an agent of Winnebago. Winnebago is not bound by any representation or warranty made by the dealer or between the dealer and the retail purchaser. Winnebago shall not be held to be a party to any aftermarket and/or third-party service contract or warranty.

THIS LIMITED WARRANTY DOES NOT PROMISE OR EXTEND TO FUTURE PERFORMANCE OF THE RV AND DOES NOT MAKE A REPRESENTATION AS TO HOW THIS RV WILL PERFORM IN THE FUTURE. THIS LIMITED WARRANTY ONLY REPRESENTS WHAT THE REMEDY WILL BE IF A SUBSTANTIAL DEFECT EXISTS.

LIMITATION AND DISCLAIMER OF WARRANTIES: THIS LIMITED WARRANTY IS IN PLACE OF ANY AND ALL OTHER WARRANTIES, EXPRESS OR IMPLIED, INCLUDING ANY IMPLIED WARRANTY OF MERCHANTABILITY OR IMPLIED WARRANTY OF FITNESS. ANY WARRANTY THAT IS FOUND TO ARISE BY WAY OF STATE OR FEDERAL LAW, INCLUDING ANY IMPLIED WARRANTIES OF MERCHANTABILITY OR IMPLIED WARRANTIES OF FITNESS, IS LIMITED TO AND DOES NOT EXTEND BEYOND THE SCOPE AND DURATION OF COVERAGE, AS SET FORTH IN THIS LIMITED WARRANTY.

NOTE: SOME STATES DO NOT ALLOW LIMITATIONS ON HOW LONG AN IMPLIED WARRANTY LASTS, SO THE ABOVE LIMITATION MAY NOT APPLY TO YOU.

DISCLAIMER OF CONSEQUENTIAL DAMAGES: WINNEBAGO SHALL NOT BE RESPONSIBLE OR LIABLE FOR ANY INCIDENTAL OR CONSEQUENTIAL DAMAGES OF ANY KIND THAT MAY RESULT FROM A BREACH OF THIS LIMITED WARRANTY OR ANY IMPLIED WARRANTY. THE EXCLUSION OF THE CONSEQUENTIAL AND INCIDENTAL DAMAGES SHALL BE INDEPENDENT OF ANY FAILURE OF THE ESSENTIAL PURPOSE OF ANY WARRANTY. THIS LIMITED WARRANTY DOES NOT COVER ANY LOSS OF USE OF THE RV.

NOTE: SOME STATES DO NOT ALLOW THE EXCLUSION OR LIMITATION OF INCIDENTAL OR CONSEQUENTIAL DAMAGES, SO THE ABOVE LIMITATION OR EXCLUSION MAY NOT APPLY TO YOU.

Important Terms Applicable to Winnebago Towables Warranties Service:

This RV is designed solely for its intended purpose of short-term recreational camping. It is normal to expect some warranty service during the Limited Warranty Period. If the need for warranty service should arise, you should contact your independent authorized selling dealer (to the extent possible) or local independent authorized dealer to schedule the repairs. Owner shall deliver this RV for warranty service within a reasonable time after discovery of the Substantial Defect and within the applicable Warranty Period. All expenses incurred in obtaining warranty service, including but not limited to gas, mileage, and accommodations, shall be the Owner's responsibility.

NOTE: WINNEBAGO TOWABLES DOES NOT CONTROL INDEPENDENT AUTHORIZED DEALERSHIPS OR THE SCHEDULING OF REPAIRS AT THEIR FACILITIES AND YOU MAY ENCOUNTER DELAYS.

If you encounter difficulty obtaining warranty service, please contact Winnebago Towables' Customer Care Department at:

Factory: 201 14th St. Middlebury, Indiana 46540

Service Center: 5200 Hoffman St. Elkhart, Indiana 46516

Phone: (574) 825-8052

Fax: (574) 825-0818

Email: RetailWOI@Winnebagoind.com

Defect vs. Damage

The Winnebago Towables Limited Warranty only covers "Substantial Defects" in materials or workmanship attributable to Winnebago's manufacture and assembly of the RV, not "damages." "Damages" include issues or repairs stemming from misuse or collision that occurs after the purchase of the RV by the first retail purchaser, as well as repairs due to lack of maintenance, because it is the owner's responsibility to maintain the RV. See Owner's Responsibilities and Maintenance below.

Goodwill Repairs

Performance of repairs on portions of the RV "Excluded from Coverage" or after expiration of the Limited Warranty Period shall be considered "Goodwill" repairs. Winnebago is not obligated to perform Goodwill repairs and performance of Goodwill repairs shall not alter the express terms of the applicable Limited Warranty.

Repair Remedy & Notice

REPAIR REMEDY: Winnebago's SOLE OBLIGATION under this Limited Warranty is to repair any covered Substantial Defect discovered within the applicable Limited Warranty Period if not excluded under the terms of this Limited Warranty. If the authorized selling dealer or local independent authorized dealer does not adequately repair the RV, the Owner must provide written NOTICE by contacting Winnebago Towables IN WRITING at 201 14th St., Middlebury, IN 46540 and advise it of any Substantial Defect(s), including a list of the Substantial Defect(s), and provide Winnebago (and not authorized dealer) an opportunity to repair the RV. Winnebago may require the Owner to deliver the RV to another authorized Winnebago dealer or its factory repair facilities. Winnebago, at its sole option, may cover the reasonable costs of transporting the RV to its factory. Refusal to allow Winnebago an opportunity to repair the RV will void warranty coverage for the identified Substantial Defect(s).

EXHAUSTION OF REMEDY AND LEGAL ACTION: OWNER MUST PROVIDE WRITTEN NOTICE AS DESCRIBED ABOVE AND PERMIT WINNEBAGO TOWABLES THE OPPORTUNITY TO REPAIR THE RV BEFORE OWNER MAY INITIATE ANY ACTION TO SEEK LEGAL OR EQUITABLE REMEDIES FOR BREACH OF THIS LIMITED WARRANTY OR ANY IMPLIED WARRANTIES.

Owner's Responsibilities and Maintenance

MAINTENANCE: This RV and its component parts will require routine maintenance, service, cleaning, and care. Information regarding recommended and/or required routine maintenance can be found in the Owner's Manual. You, as the individual owner of the RV, are responsible for ensuring all recommended and/or required routine maintenance is performed timely and correctly. Maintenance services are excluded from this Limited Warranty.

Parts and Design Change

Winnebago Towables reserves the right to change the parts and design of its recreational vehicles from time to time without notice and with no obligation to maintain spare parts or make corresponding changes in products previously manufactured by Winnebago Towables.

Warranty Repair and Acceptance of Terms

When you request and accept the performance of warranty repairs under the terms of this Limited Warranty, you are accepting all terms of this Limited Warranty, including but not limited to warranty limitations and disclaimers, the forum selection clause, and the clause reducing the time period when a lawsuit must be filed for any breach of warranty.

Exclusions From Coverage

The Limited Warranty Does Not Apply To:

- Any use of the RV for purposes other than short term recreational camping. Such unauthorized use includes, but is not limited to, use for commercial, business, rental, or disaster relief purposes. Registration of the RV in the name of any business entity shall be considered conclusive evidence of commercial and/or business use.
- Recreational Vehicles registered, licensed, or predominantly used outside of the United States or Canada.
- Recreational Vehicles purchased through an auction, wholesale, or from a dealer or party that is not an authorized dealer with Winnebago Towables.
- Equipment, component parts, or accessories that are working as designed but with which you are unhappy.
- Owner Maintenance, including but not limited to, maintaining, or resealing exterior seals, tightening screws, latches, locks, maintaining air filters, bulbs, caulking or re-caulking, or any other items identified in Owner's Manual as "care and maintenance."
- Damage or loss related to water leaks due to failure to properly maintain or care for the RV, such as failure to properly maintain exterior seals.
- Items that are added, installed, or changed after the RV leaves the possession of Winnebago Towables.
- Damage or loss to the RV caused by neglect, misuse, abuse, improper operation, theft, vandalism, improper balancing or overloading, accidents involving the RV, product modification, unprotected electrical hookups, failure to provide routine maintenance, unauthorized modifications, structural attachments, or repairs.
- Damage or loss caused by normal use or wear, including discoloration, or fading of exterior designs, discoloration of fading of fabrics, tearing, or deterioration caused by prolonged exposure to natural elements.
- Injury, damage, or loss caused by improper ventilation, interior or exterior condensation, mold, mildew, or fungi.
- The chassis including without limitation, any mechanical parts or systems of the chassis, frame, axles, tires, tubes, batteries, gauges, or optional generators.
- Damage or loss caused by infestation of insects or animals.
- Damage or loss caused by factors not attributable to Winnebago Towables such as road hazards, off road use, rocks, tire wear, tire failure, glass breakage, exposure to fumes emitted by other vehicles, corrosion or rust due to the environment, salt, corrosive chemicals, air pollutants, or condensation.
- Any appliance, component, system, or part of the RV that is covered by another limited warranty. These items include but are not limited to, roof air conditioners, microwave, refrigerator, oven, stove, CD player, television, DVD player, stereo, speakers, washer, dryer, water heater, camera, or furnace. Winnebago Towables will administer certain separate appliance and component warranties only during the one-year Limited Warranty period provided by Winnebago Towables. Please contact an authorized Winnebago Towables dealer for information on non-Winnebago Towables warranties. The terms of this Limited Warranty are not altered in any way by Winnebago Towables administering the separate appliance and component warranties.
- Adjustments to interior doors, latches, drawers, window treatments, awnings, tubes, and locks beyond ninety (90) days after sale to first retail purchaser.
- Damages to the fiberglass caps such as rock chips, fading, impact, scratches, or failure to maintain all as described herein and set out in the Owner's Manual.
- Damage or loss caused by the willful or negligent acts of any driver of the vehicle pulling the RV, an accident involving the RV, or the condition of any road surface.
- Damage or loss to the RV caused by tow vehicle, use of the tow vehicle, improper selection, or installation of towing hitch on tow vehicle, weight distribution, sway control or equalizer equipment, or damage to RV or tow vehicle.

Legal Remedies

THIS LIMITED WARRANTY SHALL BE INTERPRETED AND CONSTRUED IN ACCORDANCE WITH THE LAWS OF THE STATE OF INDIANA. EXHAUSTION OF REMEDY AND LEGAL ACTION: THE WRITTEN NOTICE AND REPAIR REMEDY DESCRIBED ABOVE MUST BE COMPLETED PRIOR TO INITIATING ANY ACTION TO SEEK LEGAL OR EQUITABLE REMEDIES FOR BREACH OF THIS LIMITED WARRANTY OR ANY IMPLIED WARRANTIES.

ANY ACTION FOR BREACH OF THIS LIMITED WARRANTY OR ANY IMPLIED WARRANTY OR REVOCATION OF ACCEPTANCE OR ANY ACTION TO ENFORCE ANY PORTION OF THIS LIMITED WARRANTY MUST BE COMMENCED WITHIN NINETY (90) DAYS OF THE EXPIRATION OF THE WARRANTY PERIOD. SOME STATES DO NOT PERMIT REDUCTION OF THE STATUTE OF LIMITATIONS, SO THE LIMITATION MAY NOT APPLY TO YOU.

EXCLUSIVE JURISDICTION FOR DECIDING LEGAL DISPUTES RELATING TO THIS LIMITED WARRANTY, AN ALLEGED BREACH OF WARRANTY, BREACH OF IMPLIED WARRANTIES, OR REPRESENTATIONS OF ANY KIND MUST BE FILED IN THE COURTS WITHIN THE STATE OF INDIANA.

ANY AND ALL CLAIMS OR CAUSES OF ACTION ARISING OUT OF OR RELATING TO THIS LIMITED WARRANTY OR IMPLIED WARRANTY SHALL BE GOVERNED BY THE LAWS OF THE STATE OF INDIANA, WHETHER SUCH CLAIMS SOUND IN CONTRACT, TORT, OR STATUTE (INCLUDING THE STATUTE OF LIMITATIONS), WITHOUT GIVING EFFECT TO ANY CONFLICT OF LAW RULE THAT WOULD RESULT IN THE APPLICATION OF THE LAWS OF A DIFFERENT JURISDICTION.

NOTE: ANY AUTHORIZATION OR PERFORMANCE OF REPAIRS, ATTEMPTS TO RESOLVE A COMPLAINT, OR REQUEST FOR WARRANTY SERVICE SHALL NOT CONSTITUTE A WAIVER OF WINNEBAGO TOWABLES' RIGHTS AND SHALL NOT EXTEND THE WARRANTY COVERAGE PERIOD OR WHEN YOU MUST COMMENCE AN ACTION TO ENFORCE ANY BREACH OF WARRANTY CLAIMS, UNLESS PROHIBITED BY STATE LAW.

THE ABOVE LIMITED WARRANTY GIVE YOU SPECIFIC LEGAL RIGHTS. YOU MAY ALSO HAVE OTHER RIGHTS, WHICH VARY FROM STATE TO STATE AND PROVINCE TO PROVINCE.

Coach-Net Coverage

All Winnebago travel trailers come with one-year of Coach-Net’s Basic roadside and RV technical assistance. This means the registered unit and the towing vehicle, if attached at the time of service, are covered 24/7 throughout the United States and Canada. They offer sign and drive coverage, which means no out of pocket expense for covered services, the owner is responsible for parts and labor, if required for the service. You are eligible for unlimited services, for example if you require 3 tows and one battery boost in one week it will be covered at no charge. If you need assistance with common operational issues; slides/jacks not retracting, resetting breakers, connecting to shore power, simply call Coach-Net to request RV technical assistance. All Coach-Net Techs are industry and manufacturer trained and we have been partnered with them for over 30 years.

Basic Benefits & Services











Basic Membership



BENEFITS & SERVICES





Coverage

-  **Covers one RV only**
 Membership covers one towable RV and the tow vehicle when attached.
-  **Coverage in the United States & Canada**
 Emergency roadside assistance is available 24 hours a day anywhere in the United States and Canada.



-  **Unlimited Battery Boosts**
 A battery boost for your vehicle’s dead battery or a tow to a repair facility.
-  **Unlimited Lockouts**
 Delivery of locksmith services to your vehicle and assistance in the opening of your locked vehicle, and/or obtaining a replacement key.
-  **Delivery of Fuel & Emergency Fluids**
 Delivery of gasoline, oil, water, transmission fluid, power steering fluid and brake fluid to your disabled vehicle.
-  **Emergency Trip Interruption**
 Up to \$2,000 reimbursement for automobile rental, food and lodging made necessary by the disablement of your RV due to a collision more than 100 miles from your home.
-  **Winching**
 Winch out or extraction services required in order to tow the disabled vehicle. Covered up to 100 feet off a maintained road or in a commercial campground equipped for camping vehicles.
-  **Trip Planning**
 Receive maps marked with the most scenic or most direct routing along with a travel checklist, tourism information, low clearance bridge information and important travel information by state.

-  **Mobile Mechanic**
 Dispatching of mechanic to the site of your mechanically-disabled vehicle.
-  **Service Appointment Services**
 Locator service to obtain the first available appointment at the closest, qualified facility and provide directions, appointment time & facility contact.
-  **Proprietary Dispatch Technology & Call Center**

Services

-  **RV Technical Assistance Hotline**
 The RV Technical Assistance Hotline is available to you 24/7. Our technicians can guide you through common operational issues you might experience.
-  **Unlimited Towing**
 No mileage or dollar amount limits - no out-of-pocket expense when towing your disabled vehicle to the nearest **qualified** repair facility.
-  **Unlimited Tire Assistance**
 Changing of your vehicle’s flat tire, delivery of a comparable tire or towing of your vehicle to a repair facility.

Discounts

-  **Camping Discounts**
 Wherever your journey takes you, there is an RV park just waiting to become your home on the road. Coach-Net has partnered with campgrounds across the U.S. and Canada to provide you savings.
-  **Travel & Entertainment Discounts**
 Members receive exclusive discounts and special offers on entertainment, travel destinations, and merchandise at hundreds of retail partners.

24/7 RV TECHNICAL & ROADSIDE ASSISTANCE
 Winnebago Towable Units

coach-net.com/winnebago

These brief summaries do not constitute a complete description of benefits to the member. Limitations and exclusions apply. If there are any discrepancies between this document and the Member Benefit Guide, the Guide will govern.



For more information, scan the Coach-Net QR code sticker placed in your unit.

CONTACT US

| Factory: 201 14th St. Middlebury, IN 46540 |
| Service: 5200 Hoffman St. Elkhart, Indiana 46516 |
| Phone: 574-825-5250 | Fax: 574-825-0818 |
| Email: RetailWOI@Winnebagoind.com |
| Website: www.winnebago.com |